

# Ambersil

Product Range

Since 1948

ISSUE 8

PAINTS

ANTI-CORROSION

GREASES

POLYMER PROCESSING

LUBRICANTS

DEGREASERS

METAL WORKING

CLEANERS

**YOUR  
COMPLETE  
CHEMICAL  
SOLUTION™**

# CONTENTS BY SECTION

## CLEANERS & DEGREASERS

Amberclens	14
Amberclens FG	14
Ambersolv / AB1	14
Degreaser RTU	14
Degreaser FG	15
Stainless Steel Cleaner FG	15
Hard Surface Cleaner	15
Citrus Cleaner & Degreaser	15
Traffic Film Remover	16
Sugar Remover & Inhibitor FG	16
Terrazzo Anti-Slip Floor Cleaner	16
SBP11	16
White Spirit	17
DP17	17
Yellow Hand Cleaner	17
Solvent Free Hand Cleaner	17
Tough Wipes	18
Hand Cleaning Wipes	18
Hard Surface Sanitising Wipes	18
Engineers Wipes	18
Amberklene FE10	19
Amberklene ME20	19
Amberklene LO30	19
Brake Cleaner	19
Industrial Degreaser FG	20
Solvent Cleaner FG	20
Solvent Degreaser	20
Amberklene FG	20
Lec-Klene	21
Ambersolv SB1	21
Fast Clean 200/201	21
BA40 Solvent	21
Paint & Graffiti Remover	22
Gasket Stripper GS5	22
Multi-Surface Polish	22
Glass Cleaner	22
Air Duster	23
Air Duster FG	23
Invertible Air Duster	23
Dust Remover	23
Duster LO-GWP	24
Anti-Static Spray	24
Universal Screen Cleaner	24
Label Remover	24
Label & Adhesive Remover FG	25
Ambertron	25
NF Precision Cleaner	25
Contact Cleaner FG	25
IPA Solvent	26
PCB Cleaner	26
Flux Remover	26
CCL 100	26
Ultrasonic Cleaning Fluid	27
Acrylic Conformal Coating	27
SV100	27
Freezer	27

## LUBRICANTS

40+	30
PX24	30
Moisture Remover FG	30
Machine Oil FG	30
Multi-Lube	31
AGL 1	31
Penetrating Oil	31
Penetrating Oil FG	31
Rust Flash	32
Silicone Lubricant	32
Silicone Anti-Stick	32
Silicone FG	32
Amberglide	33
Dry Film Anti-Stick	33
Dry PTFE Lube FG	33
Dry Moly	33
Copper Anti-Seize Paste	34
Assembly Paste FG	34
Gear and Wire Rope Lubricant	34
Chainspray	34
Chain Lube FG	35
Wire Rope Lubricant	35
Belt Dressing FG	35
Blue Adhesive Lubricant	35
Graphite Release Spray	36
Ambergrease EXL	36
Ambergrease FG1	36
Ambergrease FG2	36
Ambergrease FG3	37
Hi-Load Lube FG	37
Food Grease FG	37
White Spray Grease	37
Ambergrease SIL	38
AMS4 Silicone Grease	38
3H Oil FG	38
Silicone Oil	38
Hydraulic Oil Super 32 FG	39
Hydraulic Oil Super 46 FG	39
Hydraulic Oil Super 68 FG	39
Gear Oil Super 150 FG	39
Gear Oil Super 220 FG	39
Gear Oil Super 320 FG	39
Multi Oil 32 FG	40
Multi Oil 46 FG	40
LO Oils (FG)	40

## METAL WORKING

Tufcut Liquid	44
Tufcut Spray	44
Tufcut Foam	44
Tufcut Compound	44
Tufcut Aqua	44
Spatter Release	44
Bioweld & Bioweld 670B	45
Easy Weld	45
Leak Detector	45
Flaw Detector Cleaner 1	45
Flaw Detector Penetrant 2	45
Flaw Detector Developer 3	45

## ANTI-CORROSION / PAINTS

Cold Galvanise	48
Bright, Cold Galvanise	48
Galvanising Zinc Rich	48
Galva Shine	48
Corrosion Inhibitor	49
Battery Terminal Protector	49
Alu Hi-Temp	49
Inox 200	49
Marker Pens	50
Aqua Marker Pens	50
Zinc Primer	50
Rust Converter	50
Acrylic Paint	51
Galva Colour	51

## ADHESIVES / SEALANTS

Adhesive HS300	52
Adhesive MP100	52
Adhesive NC500	52
Adhesive QS900	52
5024A Silicone Adhesive Sealant	53
5005A Silicone Adhesive Sealant	53
High Temp. Gasket Sealant	53
5-Minute Epoxy	53

## POLYMER PROCESSING

### Silicone Release Agents

Formula 6	56
Formula 1/HT	56
Formula 2	56
Formula 8	56
Formula 20	57
Silicone Release FG	57
HD-Sil Release	57
PUR 400	57

### Non-Silicone Release Agents

Formula 5	58
Formula 4	58
Formula 7	58
Formula 10	58
Formula 11	59
Non-Silicone Release FG	59
Formula 12	59
Formula 14	59
No-Sil Release	60

### Other Release Agents

Release 100	60
DP200	60
MPR 100	60
MPR 200	61
COM 300	61
COM 400	61
PUR 101	61
PUR 300	62
ROM 300	62
RBR 100	62
RBR 310	62

### Anti-Corrosion & Misc. Cleaning

Mould Protective	63
Green Mould Protective	63
Blue Mould Protective FG	63
Tool Guard	64
Clear Mould Protective	64
Polymer Remover	64
Polyklene R	64
Mould Cleaner	65
Solvent Cleaner FG	65
Polyester Mould Cleaner	65
Mould Solv	65
Ejector Pin Lubricant	63

## key code



Available in 5 Litres



Available in 25 Litres



Available in 200 Litres



Available in 12.5 Kg



Available in 100g



Available in 200ml



Available in 350ml



Trigger Spray



Available in 400g



Available in 30 Wipes



High Temp Resistant



Non-Flammable



MOD Approval



Aerospace Approval



Rail Approval



Automotive Approval



Bio-degradable



360° Spray System



NSF Registered



# CONTENTS BY INDUSTRY

## INDUSTRIAL MRO CLEANERS

Amberclens	14
Amberklene FE10	19
Amberklene LO30	19
Amberklene ME20	19
Ambersolv / AB1	14
Ambersolv SB1	21
Citrus Cleaner & Degreaser	15
Degreaser	14
Hard Surface Cleaner	15
Traffic Film Remover	16
Fast Clean 200/201	21
Paint & Graffiti Remover	22

## LUBRICANTS

40+	30
AGL 1	31
AMS4 Silicone Grease	38
Amberglide	33
Ambergrease EXL	36
Ambergrease SIL	38
Chainspray	34
Copper Anti-Seize Paste	34
Silicone Lubricant	32
Silicone Oil	38
Penetrating Oil	31
PX24	30
Rust Flash	32
Silicone Anti-Stick	32
Dry Film Anti-Stick	33
Dry Moly	33
Gear and Wire Rope Lubricant	34
Wire Rope Lubricant	35

## METAL WORKING

Bioweld & Bioweld 670B	45
Easy Weld	45
Spatter Release	45
Flaw Detector Cleaner 1	45
Flaw Detector Penetrant 2	45
Flaw Detector Developer 3	45
Leak Detector	45
Marker Pens	50
Aqua Marker Pens	50
Tufcut Aqua	44
Tufcut Compound	44
Tufcut Foam	44
Tufcut Liquid	44
Tufcut Spray	44

## ANTI-CORROSION

Cold Galvanise	48
Bright, Cold Galvanise	48
Corrosion Inhibitor	49
Acrylic Paint	51
Galva Colour	51
Galva Shine	48
Galvanising Zinc Rich	48
Inox 200	49
Alu Hi-Temp	49
Rust Converter	50
Zinc Primer	50
Battery Terminal Protector	49

## ADHESIVES

5-Minute Epoxy	53
Adhesive HS300	52
Adhesive MP100	52
Adhesive NC500	52
Adhesive QS900	52
5005A Silicone Adhesive Sealant	53
5024A Silicone Adhesive Sealant	53
High Temp. Gasket Sealant	53

## HYGIENE & FACILITIES MANAGEMENT CLEANERS

Universal Screen Cleaner	24
Label Remover	24
Glass Cleaner	22
Yellow Hand Cleaner	17
Solvent Free Hand Cleaner	17
Stainless Steel Cleaner FG	15
Multi-Surface Spray Polish	22
Paint & Graffiti Remover	22
Engineers Wipes	18
Hand Cleaning Wipes	18
Tough Wipes	18
Citrus Cleaner & Degreaser	15
Degreaser	14
Hard Surface Cleaner	15
Traffic Film Remover	16

## ELECTRICAL SERVICING

### CLEANERS

Duster Lo GWP	24
Air Duster	23
Invertible Air Duster	23
Dust Remover	23
Ambertron	25
IPA	26
Flux Remover	26
Anti-Static Spray	24
Lec-Klene	21
N F Precision Cleaner	25
PCB Cleaner	26
Ultrasonic Cleaning Fluid	27
Universal Screen Cleaner	24
Freezer	27
CCL100	26

### LUBRICANTS

AMS4	38
SV 100	27

## FOOD & BEVERAGE

### CLEANERS

Amberclens FG	14
Degreaser FG	15
Amberklene FG	20
Industrial Degreaser FG	20
Contact Cleaner FG	25
Air Duster FG	23
Label & Adhesive Remover FG	25
Stainless Steel Cleaner FG	15
Sugar Remover & Inhibitor FG	16
Solvent Cleaner FG	65
Hard Surface Sanitising Wipes FG	18

### LUBRICANTS

Machine Oil FG	30
Moisture Remover FG	30
Silicone FG	32
Belt Dressing FG	35
Chain Lube FG	35
Food Grease FG	37
Penetrating Oil FG	31
Dry PTFE Lube FG	33
Silicone Release FG	57
Non-Silicone Release FG	59

### GREASES

Ambergrease FG1	36
Ambergrease FG2	36
Ambergrease FG3	37
Hi-Load Lube FG	37
Assembly Paste FG	34

## FOOD / BEVERAGE / PHARMA OILS

Gear Oil Super 150 FG	39
Gear Oil Super 220 FG	39
Gear Oil Super 320 FG	39
Hydraulic Oil Super 32 FG	39
Hydraulic Oil Super 46 FG	39
Hydraulic Oil Super 68 FG	39
Multi Oil 32 FG	40
Multi Oil 46 FG	40
LO Oils (FG)	40

## RAIL / MASS TRANSIT / FLT

### CLEANERS

Brake Cleaner	19
DP17	17
SBP11	16
Solvent Degreaser	20
Gasket Stripper GS5	22
White Spirit	17
Terrazzo Anti-Slip Floor Cleaner	16

### LUBRICANTS

AMS4	38
FLT Chainlube	35
Multi-Lube	31
ROM 300 Pantograph Protector	62
White Spray Grease	37

## MOULDING OPERATIONS

### CLEANERS

Polyester Mould Cleaner	65
Polymer Remover	64
Mould Cleaner	65
Mould Solv	65
Polyklene R Concentrate	64
Polyklene R RTU	64
Solvent Cleaner FG	65

### SILICONE RELEASE AGENTS

Formula 6	56
Release 100	60
Formula 1	56
Formula 1/HT	56
Formula 2	56
Formula 8	56
PUR 400	57
Formula 20	57
Silicone Release FG	57

### NON-SILICONE RELEASE AGENTS

Formula 11	59
Formula 5	58
Formula 4	58
Formula 14	59
Formula 7	58
Formula 10	58
Formula 12	59
No-Sil Release	60
Non-Silicone Release FG	59

### OTHER RELEASE AGENTS

Release 100	60
ROM 300 Pantograph Protector	62
COM 300	61
COM 400	61
DP200	60
MPR 100	60
MPR 200	61
PUR 101	61
PUR 300	62
RBR 100	62
RBR 310	62

## ANTI-CORROSION

Clear Mould Protective	64
Green Mould Protective	63
Mould Protective	63
Tool Guard	64
Blue Mould Protective FG	63

# RSABOUT AMBERSIL



## WHO WE ARE

- Ambersil is the market leading brand of CRC Industries UK Ltd
- CRC UK is part of the global CRC Industries group
- We have over 60 years experience manufacturing and marketing Ambersil products

## WHAT WE DO

- We are a market leading formulator and manufacturer of MRO chemicals, developed for industrial applications
- We work cooperatively with industry to deliver true added value
- We are specialists in aerosol technology with a purpose built blending and production facility

## HOW WE DO IT

- We have a dedicated, expert sales force proactively working with end-users to solve problems and deliver true benefits
- We supply and work with a network of national, local and international distributors who can supply Ambersil products on demand
- Ambersil utilises its global connections to rapidly develop and bring to market new, tested products

## WHY WE ARE DIFFERENT

- Ambersil is dedicated to PERFORMANCE, RELIABILITY and TRUST
- Ambersil is a recognised and respected top-tier brand, worldwide
- We offer a Complete Chemical Solution for maintenance products with 100% UK availability 24/7

**“AMBERSIL IS YOUR STRATEGIC  
MAINTENANCE CHEMICAL PARTNER.”**



# DATA SHEETS



## REMOVING THE HEADACHE FROM SDS SHEET UPDATING

A service offered to Ambersil end-users and distributors as a means to automate the task of updating Safety Data Sheets (SDS) and Technical Data Sheets (TDS), reducing the burden on staff having to remember, schedule, and undertake this important requirement.

A unique service making compliance easy!

- 24/7 availability on-line
- Eliminates the potential to 'forget' to check for updates
- Saves time & easy to use
- Legislation changes frequently; do you always know when it has?
- Receive updates automatically
- All information held securely
- Register up to four email addresses – keeps all key personnel informed

## My Ambersil A Step By Step Guide

1 Navigate to [www.ambersil.com](http://www.ambersil.com)

2 Click on the My Ambersil logo

3 Select the link "New user: register"

4 Fill in company details and up to 5 email addresses

5 The unique log-in ID and password will be emailed to you

6 Enter the log-in ID and password on the My Ambersil homepage

7 Once logged in, select the country from the drop-down list at the top of the page (e.g United Kingdom)

8 No products will be displayed yet as My Ambersil defaults to your selected products. To add products, simply untick the 'My Selection' box

9 The complete list of Ambersil products will now be displayed - using the selection boxes on the right, both MSDS and TDS updates can be selected

10 Select the Ambersil products of interest, by navigating through each page. My Ambersil remembers your selection as you move between pages, but it needs to be 'saved' by clicking 'update' before closing the website

If product selection needs to be modified, simply log-in to My Ambersil and change the update options (click on the My Ambersil logo to update email preferences)

# QUALITY CONTROL



## ACCREDITED ISO 9001:2008

We understand your reliance on quality and conformance, and value your trust in us to deliver. All Ambersil products undergo stringent quality control tests at every stage of product production.

Our product specification procedures begin many months (and even years) before a new product is launched and encompass pilot plant trials, field trials and long-term storage stability testing. By rigorously applying these procedures to all our products, we can ensure the highest levels of reliability, safety and performance in use.

We have many products specified or approved by large, blue-chip organisations and government bodies, including: MoD, NATO, Rolls Royce, Ford, Rail Operators, Boeing, McDonnell Douglas, Pratt and Whitney, British Standards, British Airways, NSF and many more. See product entries for details.

## FULLY COMPLIANT WITH CURRENT LEGISLATION, AND PRO-ACTIVELY WORKING TOWARDS FUTURE LEGISLATION



(Certificate number FM26077)

Checks routinely performed on Ambersil Aerosols include:

### 1. Raw material testing

To confirm that all product ingredients are as specified

### 2. Bulk blend testing

All product batches are tested for conformance to predefined specifications before being filled into aerosol packs.

Typical tests include:

- Specific gravity checks
- Viscosity checks
- Moisture content analysis
- Infra-red analysis

### 3. Filled aerosol testing

All filled packs are subjected to many performance and safety checks including:

- Crimp checks
- Labelling checks
- Weight checks
- Pressure checks

### 4. Water bath testing

Every single aerosol we produce passes through a hot-water bath to assess pack integrity at elevated temperatures.

### 5. Storage trials

Prior to production, Ambersil products are tested for long-term storage and reliability trials - that's why most Ambersil products have a shelf life of 6-years!

### 6. Product specific tests

Different product applications will require specific test criteria, such as accelerated corrosion testing, evaluation of release properties and material compatibility testing.



# ENVIRONMENTAL RESPONSIBILITY



## ACCREDITED ISO 14001:2004

Located in the county of Somerset, on the edge of the Somerset Levels, near to the historic towns of Wells and Glastonbury, and a stone's throw to Exmoor National Park; here at Ambersil we recognise the need to minimise our impact on the environment so that future generations can benefit from our natural heritage.

Aerosols are recognised as one of the safest methods of storing and using maintenance chemicals due to the fact that they are hermetically sealed, eliminating spill risks and reducing environmental contamination potential.

All Ambersil aerosols have been CFC free since 1989 and we are continually innovating new procedures to minimise secondary impacts on the environment from office processes and other 'behind the scenes' activities.

All Ambersil aerosols are manufactured from fully recyclable steel or aluminium (check with relevant waste disposal regulations before disposal).

- All Ambersil steel tinplate cans can be recycled
- All Ambersil boxes used for packaging and shipping are made from 100% recycled cardboard
- All aluminium aerosols can be recycled

Ambersil is committed to managing its environmental performance, preventing pollution, ensuring compliance with all applicable environmental legislation. We strive to deliver continual improvement through the development, implementation and maintenance of an Environmental Management System that has been awarded ISO 14001:2004 certification.

All Ambersil products (including packaging) comply with directive 2002/95/EC on the Restriction of Hazardous Substances in electrical and electronic equipment (RoHS).



(Certificate number EMS60742)

# PRODUCT DESIGN

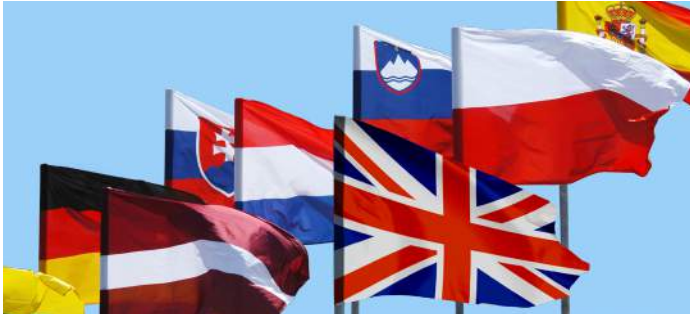

## Multi-language cans:

- Depending on the market version, aerosol products display either 26-languages or 6-languages as standard: English, Spanish, Czech, Polish, Hungarian, Portuguese
- Ambersil products can be exported globally for international branches and end-users
- Ensures non-English-speaking employees can use products (and understand safety phrases)
- Improves user safety
- All SDS are available in up to 31 languages from [www.ambersil.com](http://www.ambersil.com)

### PRODUCT NAME

The product name is in large, clear type ensuring it stands out from the rest of the can text – essential when selecting which product to use

### RANGE ICON

The Ambersil icon, clearly presented on the front of the product indicates which product range type it belongs to, assisting in easy product identification

### PRODUCT DESCRIPTION

The product description is always located directly below the range icon in bold text so that users can clearly see what the product function is. This product description is repeated in up to 6 languages below, ensuring non-English literate users can correctly identify the product

### SAFETY COMPLIANCE

Conforms to ADD for proven product safety



### MULTI-LANGUAGE

The reverse of every can (and most other pack types) clearly indicates the product description and full safety texts in multiple languages

### OUR CONTACT DETAILS

We love to hear from customers and users so every product has our details on; ask us questions or request more information



### HAZARD SYMBOLS

Clearly displayed on every product (if required), the internationally recognised CLP symbols communicate relevant hazards and precautions



# PRODUCT MODULE:

## RELEVANT INFORMATION FOR PRODUCT SELECTION

The product modules have been designed specifically to assist in the research, comparison and selection of the products. With easy to understand information such as the innovative use of 'attribute graphs' that offer a simplified representation of the product; and a QR code that instantly links to the website product page for Safety Data Sheet (SDS) & Technical Data Sheet (TDS) download.

### PRODUCT IMAGE

Clearly shows what the actual product looks like, for easier recognition

### PRODUCT NAME

Product name, as displayed on the front of the product

### APPLICATION TEXT

Example(s) of how and where the product can be used. The bullet points emphasise a selection of the key features (more are available via the QR code)

### PACK SIZE / APPROVAL ICONS

Many products carry industrial, military, aviation, or other approvals. These icons identify approvals associated with the product



## AMBERCLENS

### ANTI-STATIC FOAMING CLEANER

Use to remove general grime and soiling on all surfaces. Particularly effective as a post-maintenance cleaner for removing finger marks and oil residues. Anti-Static formulation inhibits dust attraction.

- Removes light oils, finger marks, and general grime.
- Safe for use on plastics, metals, painted and glazed surfaces
- Multiple industrial approvals: Rail, NATO, Ford, British Coal, Rolls Royce Aerospace
- Available as a non-flammable propellant version "Amberclens NB"

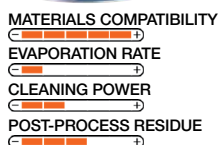

### ATTRIBUTE GRAPHS

The attribute graphs have been developed to be used as a simplified guide for comparing the key attributes of products, aiding product selection

### PRODUCT CODES

Products are often available in multiple fill sizes, from aerosols to larger bulk packs. These product fill icons indicate the fill size and container type along with the relevant product code for each variant

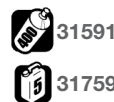

### QR CODE

Scan with a smart phone or digital device with Internet access to view datasheets, compliance letters, and product videos

# CLP-A SIMPLE GUIDE



## WHY?

- **Aim: One set of symbols, globally recognised**

The Globally Harmonised System (GHS) applies to the classification and labelling of chemicals.

The Classification, Labelling and Packaging (CLP) regulations are part of the Globally Harmonising System (GHS) which defines how chemical products are labelled. It has been designed to simplify the hazard/warning information displayed on applicable products, and which is recognised world-wide.

## WHAT?

- **EU regulation**

The classification, labelling and packaging (CLP) regulation is the European Union's response to GHS.

Under the EU regulation (EC) No1272/2008, all EU member states will implement the standardised GHS classification and labelling on chemical substances and mixtures.

## WHEN?

- **Implementation**

CLP will replace existing directives\* concerning classification and labelling:

- Dangerous Substance Directive (67/548/EEC)
- Dangerous Preparations Directive (1999/45/EC)

A transition period will allow manufacturers, suppliers and distributors to adapt their products. During this transition period both old and new systems will co-exist.

Since the 1<sup>st</sup> December 2010 all SUBSTANCES\*\* must be classified and labelled according to CLP.

From the 1<sup>st</sup> June 2015 all MIXTURES must be classified and labelled according to CLP rules. Products on the market before that date are allowed on the market for two more years without re-labelling.

	2007	2008	2009	2010	2011	2012	2013	2014	2015	2016	2017	2018	2019 onwards
CLP Timeline	Substances		Classified, labelled and packaged under DSD. If CLP is applied in full as well, no DSD labelling and packaging.		Classified under both DSD and CLP; labelled and packaged under CLP.				Classified, labelled and packaged under CLP				
	Mixtures		Classified, labelled and packaged under DSD. If CLP is applied in full as well, no DSD labelling and packaging.				Classified, labelled and packaged under CLP						
		20 Jan CLP begins		1 Dec Obligation to apply CLP to substances					1 June Obligation to apply CLP to mixtures				

\* Directive is a legislative act of the European Union which requires implementation measures by the member states

\*\*substance = a chemical element and its compounds in the natural state or obtained by any manufacturing process



## CHANGES?

### Classification

- More classes (from 14 to 26)
- Different concentration limits & different thresholds
- More classified substances and mixtures

### Labelling









- New signal words: “Danger” or “Warning”
- New pictograms
- ‘Risk phrases’ become ‘Hazard’ statements
- ‘Safety phrases’ become ‘Precautionary’ statements

### Consequences:

**NO** change in composition of the product but more classified products

**ALL** chemical products and artwork will change reflecting new signal words and pictograms

## PICTOGRAMS

OLD SYMBOL	PICTOGRAM	HAZARD CLASS	EXPLANATION
		Aerosol, cat. 1 & 2 Flammable liquids	Flammable chemicals.
		Acute toxicity, cat. 4 Skin irritation Eye irritation STOT SE, cat.3 Skin sensitisation	Harmful if inhaled, if swallowed or if in contact with skin. May cause irritation to the skin and/or eyes. May cause irritation to the airways and/or drowsiness or dizziness. May cause an allergic skin reaction.
		Aspiration hazard	May be fatal if swallowed or enters airways.
		Hazardous to the aquatic environment, acute 1, chronic 1 & 2	Toxic to aquatic life with long lasting effects.

N.B: Listed above are the hazards classes that may be seen on Ambersil products. There are other pictograms which do not apply to our products.

## HAZARD AND PRECAUTION STATEMENTS

OLD PHRASES	NEW STATEMENTS	EXPLANATION	EXAMPLE
R(isk)	H(azard)	H2xx: Physical hazard H3xx: Health hazard H4xx: Environmental hazard	H223: Flammable aerosol H315: Causes skin irritation H412: Harmful to aquatic life with long lasting effect
R(isk)	EUH(azard)	Supplemental hazard	EUH066: Repeated exposure may cause skin dryness or cracking
S(afety)	P(recautionary)	P1xx: General P2xx: Prevention P3xx: Response P4xx: Storage P5xx: Environmental	P102: Keep out of reach of children P211: Do not spray on an open flame or other ignition source P331: Do NOT induce vomiting P403: Store in a well-ventilated place. P501: Dispose of contents/ container to ...

# CLEANERS

Clean up dirt, grease & grime with the UK's most comprehensive range of industrial maintenance cleaners and degreasers

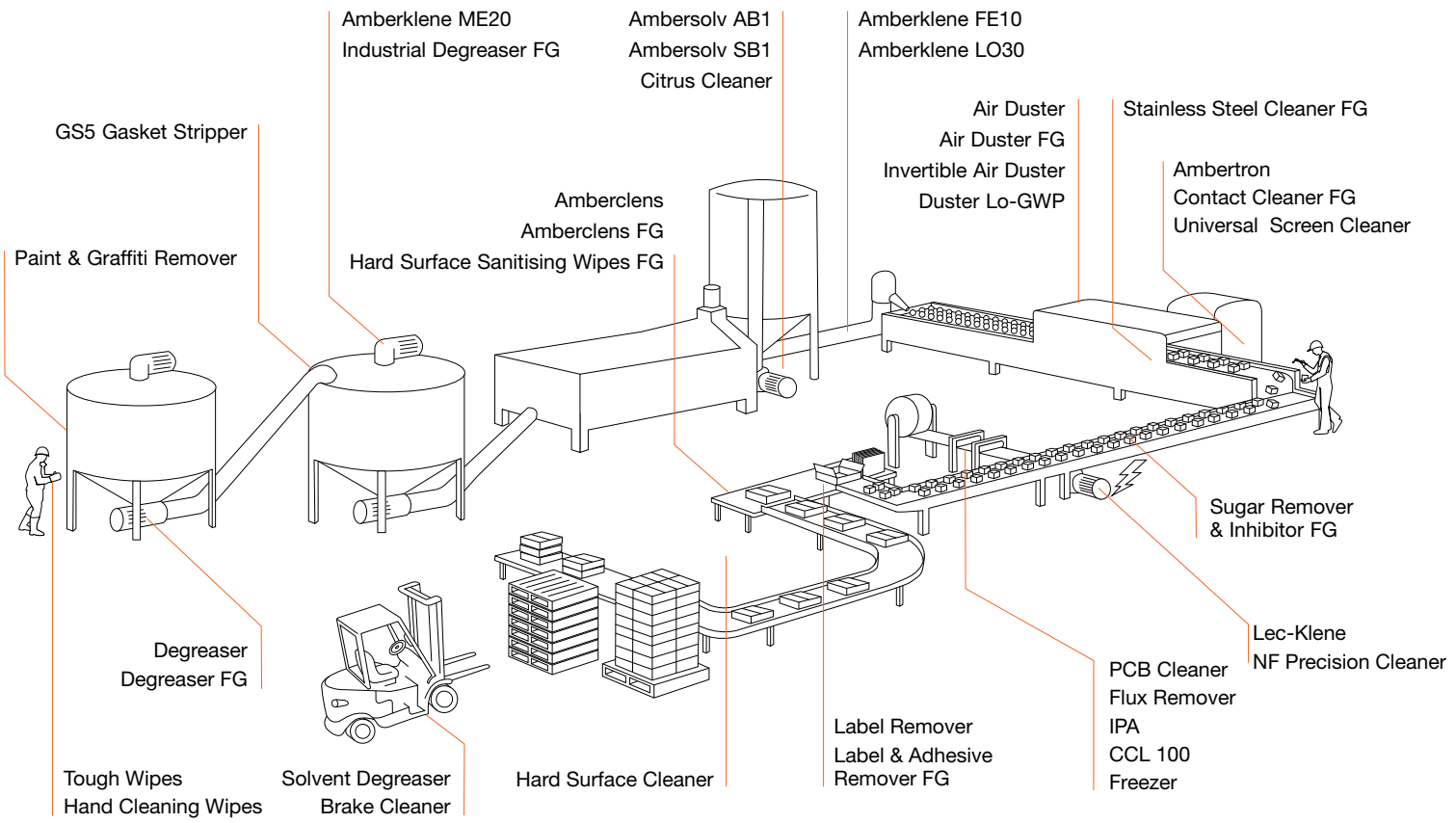

Misrepresentation Act 1967, Trade Descriptions Act 1968

The information given in this publication is based on our experience and reports from customers. There are many factors outside our control and knowledge which affect the use and performance of our products and for which reason no warranty is given, express or implied. Users should make their own tests to determine the applicability of such information or the suitability of any products for their own particular purposes. Statements concerning the use of the products described herein are not to be construed as recommending the infringement of any patent and no liability for infringement arising out of any such use is to be assumed.



# Cleaners Selection Chart

**GENERAL CLEANING**

CLEANING POWER ⊕	DEGREASER	14
	DEGREASER FG	15
	AMBERSOLV / AB1	14
	HARD SURFACE CLEANER	15
	AMBERCLENS	14
	AMBERCLENS FG	14
	UNIVERSAL SCREEN CLEANER	24
	STAINLESS STEEL CLEANER FG	15
	SUGAR REMOVER & INHIBITOR FG	16
⊖		

**SOLVENT DEGREASING**

CLEANING POWER ⊕	BA40 SOLVENT	21
	FAST CLEAN 200	21
	AMBERSOLV SB1	21
	INDUSTRIAL DEGREASER FG	20
	AMBERKLENE ME20	19
	AMBERKLENE FE10	19
	BRAKE CLEANER	19
	WHITE SPIRIT	17
	SOLVENT DEGREASER	20
	LABEL REMOVER	24
	LABEL & ADHESIVE REMOVER FG	25
	AMBERKLENE FG	20
	AMBERKLENE LO30	19
⊖		

**ELECTRONICS CLEANING**

CLEANING POWER ⊕	FLUX REMOVER	26
	LEC-KLENE	21
	AMBERKLENE LO30	19
	NF PRECISION CLEANER	25
	PCB CLEANER	26
	AMBERTRON	25
	CONTACT CLEANER FG	25
	CCL 100	16
	IPA SOLVENT	26
	ULTRASONIC CLEANING FLUID	27
	UNIVERSAL SCREEN CLEANER	24
	AIR DUSTERS	23
	⊖	

**SPECIALIST CLEANING**

CLEANING POWER ⊕	GASKET STRIPPER GS5	22
	PAINT & GRAFFITI REMOVER	22
	TERRAZZO FLOOR CLEANER	16
	TRAFFIC FILM REMOVER	16
	HARD SURFACE CLEANER	15
	CITRUS CLEANER	15
	GLASS CLEANER	22
	MULTI-SURFACE POLISH	22
	⊖	



## AMBERCLENS

### ANTI-STATIC FOAMING CLEANER

Use to remove general grime and soiling on all surfaces. Particularly effective as a post-maintenance cleaner for removing finger marks and oil residues. Anti-Static formulation inhibits dust attraction.

- Removes light oils, finger marks, and general grime.
- Safe for use on plastics, metals, painted and glazed surfaces
- Multiple industrial approvals: Rail, NATO, Ford, British Coal, Rolls Royce Aerospace
- Available as a non-flammable propellant version "Amberclens NB"

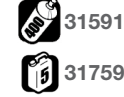

MATERIALS COMPATIBILITY  
EVAPORATION RATE  
CLEANING POWER  
POST-PROCESS RESIDUE



## AMBERCLENS FG

### FOOD GRADE FOAM CLEANER

Developed for general cleaning in the food industry. Use to remove general grime and soiling from machinery.

- NSF A1 registered (N°137995)
- Stable, non-dripping foam helps break down soiling for effective cleaning
- Cleans equipment, metal parts, and machinery
- Biodegradable



MATERIALS COMPATIBILITY  
EVAPORATION RATE  
CLEANING POWER  
POST-PROCESS RESIDUE



## AMBERSOLV AB1/FOAMING CLEANER

### WATER-BASED CITRUS CLEANER

Water-based cleaner with added citrus power. Use to clean around gearboxes, pumps and for removing hydraulic oil leak residue.

- Removes difficult soiling such as: oil, grease residue, grime, silicone, water-based paints and inks/dyes
- Ideal as a post-maintenance cleaner or as a general cleaner for removing more stubborn soiling
- Biodegradable

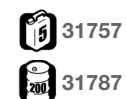
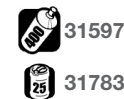

MATERIALS COMPATIBILITY  
EVAPORATION RATE  
CLEANING POWER  
POST-PROCESS RESIDUE



## DEGREASER RTU & DEGREASER LOW FOAM

### TOUGH WATER-BASED DEGREASER

Use to degrease components when a regular solvent cleaner cannot be used. Ideal for gearboxes, hydraulic systems, open gears, chains and pumps to remove a variety of soiling types.

- Removes tough, stubborn soiling such as heavy oil, grease, grime, silicones, wax and old lubricants
- Safe for use on most plastics, rubber and painted surfaces
- Available as Low Foam (LF) for automated applications
- Contains a highly effect corrosion inhibitor to help prevent flash rusting

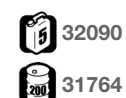
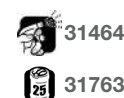

MATERIALS COMPATIBILITY  
EVAPORATION RATE  
CLEANING POWER  
POST-PROCESS RESIDUE





## DEGREASER FG

### NSF A1 WATER BASED DEGREASER

Use to degrease components when a regular solvent degreaser cannot be used. Formulated specifically for use in the food/beverage industry for risk reduction.

- NSF A1 registered (N°137997)
- Readily biodegradable and non-flammable
- Effective in both hot and cold water
- Use on gearbox housing, hydraulic systems, large panels, and even walls and floors.
- Concentrated for convenience and economy
- Non-flammable

MATERIALS COMPATIBILITY

EVAPORATION RATE

CLEANING POWER

POST-PROCESS RESIDUE



## STAINLESS STEEL CLEANER FG

### DUAL ACTION CLEANER AND POLISH

For use on all types of stainless steel and other 'shiny' surfaces to remove light oils, fingerprints, and water marks.

- NSF A7 and C1 registered (N°138212)
- Dual action: cleans and polishes in one application
- Dense foam allows use on vertical surfaces without dripping
- Leaves an invisible, non-greasy film for lasting shine
- Ideal post-maintenance cleaner

MATERIALS COMPATIBILITY

EVAPORATION RATE

CLEANING POWER

POST-PROCESS RESIDUE



## HARD SURFACE CLEANER

### WATER-BASED MULTI-SURFACE CLEANER

An environmentally preferred non-flammable product that can be used on all floors as a cleaner to remove oil, grime, bitumen residue and common soiling types.

- Can be used on almost any hard surface: concrete floors, walls, doors, marble, duct-work, signs, terrazzo, and more
- Particularly effective on sealed warehouse flooring, vinyl corridor tiles, and canteen floors
- Can be used with hot or cold water
- Very economical in use

MATERIALS COMPATIBILITY

EVAPORATION RATE

CLEANING POWER

POST-PROCESS RESIDUE



## CITRUS CLEANER & DEGREASER

### WATER-BASED CITRUS CLEANER

A powerful yet versatile cleaner and degreaser. Formulated as a complex micro emulsion of citrus oils and surfactants.

- An alternative to traditional solvents and highly alkaline cleaning agents
- Particularly effective on hard surfaces such as large pump housings, gearboxes and pipework
- Safe on most rubbers, plastics and coatings

MATERIALS COMPATIBILITY

EVAPORATION RATE

CLEANING POWER

POST-PROCESS RESIDUE





## TRAFFIC FILM REMOVER

### VEHICLE AND PLANT CLEANER

Use in automated vehicle exterior cleaning systems for HGV, mass transit and fleet cleaning.

- Easily and quickly removes oily soiling and road grime from vehicle bodies, chassis and side curtains
- Water soluble and can be diluted
- Safe for use on paint, bodywork, plastics and rubber
- Suitable for use with hot and cold water

MATERIALS COMPATIBILITY

EVAPORATION RATE

CLEANING POWER

POST-PROCESS RESIDUE



31760

31779

31780



## SUGAR REMOVER & INHIBITOR FG

### CLEANER FOR SUGAR DEPOSIT REMOVAL

Highly effective thin cleaning fluid that penetrates and lifts sugar, fondant, plant sugar extracts, and sugar derivatives from equipment surfaces.

- NSF H1 registered (N°144180)
- Formulated using only food grade acceptable components
- Leaves a light lubricating film that inhibits readhesion for easier clean-down
- Helps reduce scraping and improves equipment performance

MATERIALS COMPATIBILITY

EVAPORATION RATE

CLEANING POWER

POST-PROCESS RESIDUE



32082

31590



## TERRAZZO CLEANER

### ANTI-SLIP FLOOR CLEANER

Cleaner for anti-slip flooring that rapidly and effectively removes dirt and grime.

- Microscopically roughens terrazzo surface to provide grip when the floor is wet
- Economical in use
- Rail approved (007/025012)

MATERIALS COMPATIBILITY

EVAPORATION RATE

CLEANING POWER

POST-PROCESS RESIDUE



31872



## SBP 11

### VERSATILE CLEANING SOLVENT

A complex mix of hydrocarbons that rapidly breaks down grime for effective train and rolling stock cleaning.

- Formulated with a slower evaporation rate for longer contact time on heavy and old grease and lubricant deposits.
- The powerful solvent blend enables this degreaser to penetrate tough, oily, and viscous contamination easily.
- Rail approved (007/068267)

MATERIALS COMPATIBILITY

EVAPORATION RATE

CLEANING POWER

POST-PROCESS RESIDUE



31870-AB

31870-AC





## WHITE SPIRIT



### PETROLEUM DISTILLATE SOLVENT

Ideal for general, low intensity degreasing of parts and components.

- Highly refined to give consistent results
- Superior wetting out properties ensures effective contamination contact and performance
- Can be used as a general purpose thinner
- Conforms to BS 245
- Rail approved (007/029302)

#### MATERIALS COMPATIBILITY

EVAPORATION RATE

CLEANING POWER

POST-PROCESS RESIDUE



31870-AA



31871



## DP17



### EXTERIOR CLEANER FOR TRAINS

A mildly alkaline concentrated cleaner for the exterior of trains and other rolling stock.

- Non-corrosive to all commonly used metals, rubbers and elastomers
- Fully biodegradable surfactants
- Formulated to be used in automated train cleaning equipment
- Suitable for manual cleaning operations
- Rail approved (007/021836)

#### MATERIALS COMPATIBILITY

EVAPORATION RATE

CLEANING POWER

POST-PROCESS RESIDUE



31867



31868



31869



## YELLOW HAND CLEANER



### HEAVY DUTY HAND CLEANER

For use in engineering workshops for the removal of general grime and heavier soiling from hands.

- Use for the removal of heavy and ingrained soiling from hands such as: uncured adhesives, paint, dye, ink and heavy greases
- Polymer beads lift dirt and grime easily and gently
- Exceptionally economical in use - only a small amount is required to clean hands
- Use with washroom facilities

CLEANING POWER

ANTI-PATHOGEN

SKIN KIND

DRYING TIME



31794



31795



## SOLVENT FREE HAND CLEANER



### NATURAL HAND CLEANER

For use in engineering workshops for the removal of general grime and oil from hands.

- Gently removes medium-level soiling from hands
- Exceptionally economical in use - only a small amount is required to clean hands
- Natural ingredients and zero solvent content helps maintain skin health
- Use with washroom facilities

CLEANING POWER

ANTI-PATHOGEN

SKIN KIND

DRYING TIME



31793





## TOUGH WIPES



**HIGH ABSORBENCY HAND CLEANING WIPE**  
 High absorbency hand wipes over-layered with a polymer web for all the deep cleaning power of pumice in a handy wipe.

- Highly effective on a range of soiling types: adhesives, grease, oil, tar, silicone, resins, paints, and more
- Contains anti-pathogen agents highly effective against common bacteria and viruses such as Weils Disease, MRSA, Salmonella, Listeria, and E.Coli. Passes BS 12054 (hand sanitising) and BS 1276 (surface sanitising)
- No contamination or lasting fragrance from heavy perfumes



30 30766

100 30767



- CLEANING POWER
- ANTI-PATHOGEN
- SKIN KIND
- DRYING TIME

## HAND CLEANING WIPES



**READY TO USE HAND & TOOL WIPES**

Use for cleaning light to moderate grime and oil from tools, hands, and equipment.

- Economical hand cleaning
- Keeps expensive hand tools clean
- Multi-purpose disposable wipes
- Combats common germs
- Excellent materials compatibility



150 31798



- CLEANING POWER
- ANTI-PATHOGEN
- SKIN KIND
- DRYING TIME

## HARD SURFACE SANITISING WIPES FG



**“NO RINSE REQUIRED” SANITISING WIPES**

Hard surface sanitising wipes developed for the food and beverage industry. Suitable for use on production lines and in processing areas.

- Kills common pathogens such as: Staphylococcus aureus, E.Coli, Pseudomonas aeruginosa, and Enterococcus hirae
- Sanitised surfaces do NOT require a rinse after product use, ensuring production efficiency and speed is maintained
- Highly visible blue wipes for contamination risk reduction
- NSF D2 registered (N°147561)



1000 32325



- CLEANING POWER
- ANTI-PATHOGEN
- FOOD SAFE
- DRYING TIME

## ENGINEERS WIPES



**LOW/ZERO LINT CLEANING WIPES**

High quality, extremely low lint dry wipes for use with all Ambersil solvents, cleaners, lubricants.

- Tear resistant and “non-linting”
- Suitable for use with all Ambersil chemicals
- Excellent wet strength - resists tearing and can be reused
- Ideal for use on delicate surfaces: computer monitors, touch screens, LCD/plasma screens, and more
- Highly absorbent



50 31797



- MATERIALS COMPATIBILITY
- EVAPORATION RATE
- CLEANING POWER
- POST-PROCESS RESIDUE





## AMBERKLENE FE10

### FAST DRYING SOLVENT DEGREASER

Use for the general degreasing of machinery including chains, gears, bearings, drives, motors, and more.

- Powerful flushing action rapidly dissolves and removes contaminants
- Safe for use on all metals and most plastics
- Zero residue - perfect for surface preparation prior to bonding, painting, coating, or relubrication
- Fitted with the Ambersil 360 degree spray system for all angle use

MATERIALS COMPATIBILITY

EVAPORATION RATE

CLEANING POWER

POST-PROCESS RESIDUE



31553

32116

31563

30308

31697



## AMBERKLENE ME20

### HEAVY DUTY SOLVENT

Formulated with a slower evaporation rate for longer contact time on heavy grease and old lubricant deposits.

- Removes heavy, old, and significant deposits of oil, grease, waxes and silicone
- Superior wetting properties ensures extended contact time and solvency performance
- Higher flash point of 41°C for application safety
- Leaves a clean, dry, residue free surface

MATERIALS COMPATIBILITY

EVAPORATION RATE

CLEANING POWER

POST-PROCESS RESIDUE



31554

31636

31698

30309



## AMBERKLENE LO30

### LOWER ODOUR SOLVENT DEGREASER

Use for general light degreasing on bearings, motors, gears and chains without the traditional odour associated with solvent degreasers.

- Safe for use on ferrous and non-ferrous metals, most painted surfaces, and most plastics
- Will not stress-crack acrylic
- Listed in British Airways 'Standard Practice' manual. Meets US Federal Spec. TT-N-95Bv Type 2; and is approved by Ford Motor Company (Tox: 166741)

MATERIALS COMPATIBILITY

EVAPORATION RATE

CLEANING POWER

POST-PROCESS RESIDUE



31555

31699

31700

31701



## BRAKE CLEANER

### AUTOMOTIVE SOLVENT CLEANER

Use on all brakes and clutches to remove dust deposits, oil, grease, and other contaminants. Also removes anti-corrosion coatings on new brake discs prior to fitting.

- Reduces disc brake squeal and clutch chatter
- Can be used as a general purpose degreaser
- Safe for use on metals, most plastics, coatings and rubbers (test prior to use).

MATERIALS COMPATIBILITY

EVAPORATION RATE

CLEANING POWER

POST-PROCESS RESIDUE



30282

31772





## INDUSTRIAL DEGREASER FG

### HEAVY DUTY, FAST EVAPORATING SOLVENT

Formulated for use in the food/beverage industry to tackle 'difficult' degreasing applications. Excellent general purpose solvent degreaser.

- NSF A8 and K1 registered (N°140255 and 140250)
- Powerful flushing action with superior wetting properties ensures excellent results
- Zero residue



MATERIALS COMPATIBILITY

EVAPORATION RATE

CLEANING POWER

POST-PROCESS RESIDUE



## SOLVENT CLEANER FG

### LOW ODOUR SOLVENT DEGREASER

Use for the general degreasing of mould tools, bearings, and equipment in the food and beverage sector.

- NSF K1 registered (N°149687)
- Minimal odour
- Cuts through oils, grease residues, mould release agents, polymer residues, and anti-corrosion coatings
- Zero residue
- Good materials compatibility



MATERIALS COMPATIBILITY

EVAPORATION RATE

CLEANING POWER

POST-PROCESS RESIDUE



## SOLVENT DEGREASER

### WATER RINSABLE DEGREASER

Use for engine and equipment degreasing which can be washed down, or for use in enclosed environments where vapours need to be minimised.

- Contains a highly effective emulsifier that enables dissolved oil/grease residues to mix with water for easy wash-off
- Higher flash point of 39°C for application safety



MATERIALS COMPATIBILITY

EVAPORATION RATE

CLEANING POWER

POST-PROCESS RESIDUE



## AMBERKLENE FG

### BIODEGRADABLE SOLVENT DEGREASER

A medium/slower evaporation solvent degreaser for use in the food/beverage sector. Use to remove grease and oils from bearings, housings, conveyor drives, chains and even wax-based anti-corrosion coatings.

- NSF A8 and C1 registered (N°137996 and 140261)
- Higher flash point of 40°C for application safety



MATERIALS COMPATIBILITY

EVAPORATION RATE

CLEANING POWER

POST-PROCESS RESIDUE





## LEC-KLENE

### HIGH FLASH POINT SOLVENT DEGREASER

An advanced high flash point solvent degreaser for electronic and aviation components. The ultra-pure formulation delivers a good level of solvency power with excellent materials compatibility.

- A fast and effective general purpose degreaser
- Higher flash point (>62°C) for application safety
- Use where DEF STAN 68-148 is specified
- No detrimental effect on painted surfaces, ferrous or non-ferrous metal, epoxy based composites, acrylic sheet, plastics, and rubber



- 31557
- 31702
- 31704

- 31969
- 31703



## AMBERSOLV SB1

### CITRUS BASED SOLVENT DEGREASER

A solvent degreaser with added citrus power for use on grease and grime that may contain multiple contamination types. Ideal for use in the printing industry.

- Effective on a wide range of soiling such as: oil, grease, tar, bitumen, silicones, rubber-based adhesives, oil-based paints, inks and dyes
- Safe for use on most plastics and all metals
- Military & Aviation approved



- 31598
- 31786

- 31785



## FAST CLEAN 200/201

### EXTRA FAST & POWERFUL SOLVENT

An advanced degreasing solvent that has both exceptionally fast drying speed and very high solvency power.

- Removes heavy, old, and dried-on deposits of oil, grease, waxes and silicone
- Powerful flushing action rapidly dissolves and removes contaminants
- Non-chlorinated
- Zero residue



- 31890
- 32115

- 32114



## BA40 SOLVENT

### AVIATION SPECIFIED SOLVENT CLEANER

Developed specifically for the demands of the aviation industry for a cleaner to remove uncured polysulphide sealant.

- Also removes other stubborn residues such as: adhesives, inks, resins, varnishes and lacquer
- Powerful solvent for excellent penetration but with rapid evaporation for maximum efficiency
- Low pressure spray provides an even coverage and prevents splash back in use
- Zero residue

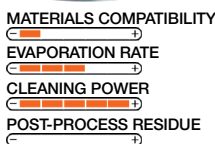

- 31556





## PAINT & GRAFFITI REMOVER

### POWERFUL PAINT REMOVER

A highly effective solution to the difficult problem of removing graffiti and old paint.

- Rapidly softens existing paint for easier removal prior to repainting with Ambersil Acrylic Paint or Galva Colour
- For use on hard, non-porous surfaces. Test substrate compatibility prior to use
- Softens acrylic paint in 3 minutes, and softens tough paints in 10 minutes

MATERIALS COMPATIBILITY

EVAPORATION RATE

CLEANING POWER

POST-PROCESS RESIDUE



31630



## GASKET STRIPPER GS5

### UNIVERSAL GASKET STRIPPER

Removes in-place gaskets from gearboxes, drives, chain enclosures, and engines.

- Use to remove thread locking compounds, silicone sealant, and mastics
- Foaming formulation extends contact time and assists in gasket softening
- Fast acting: works in less than 20 minutes
- Reduces scraping and potential damage to surfaces

MATERIALS COMPATIBILITY

EVAPORATION RATE

CLEANING POWER

POST-PROCESS RESIDUE



310891



## MULTI-SURFACE POLISH

### CLEANER AND POLISH FOR HARD SURFACES

Developed to cut through and remove industrial soiling which is often more tenacious than domestic dust/grime.

- Wax/silicone blend provides a durable, high gloss shine
- Pleasant fragrance leaves the area smelling fresh and clean
- Works rapidly to capture dust and grime for rapid “one-application” cleaning
- Use with Ambersil Engineers Wipes for best results

MATERIALS COMPATIBILITY

EVAPORATION RATE

CLEANING POWER

POST-PROCESS RESIDUE



31596



## GLASS CLEANER

### FOR GLASS AND GLAZING

Use on all glazed and ceramic surfaces to remove light soiling and marks.

- Produces a smear-free and residue-free finish with minimal effort
- Incredible results, first time
- Automotive approval: Ford Tox No: 177057

MATERIALS COMPATIBILITY

EVAPORATION RATE

CLEANING POWER

POST-PROCESS RESIDUE



31596







## AIR DUSTER

### NON-FLAMMABLE DUSTER FOR ELECTRONICS

A high pressure, inert, liquefied gas that safely removes dust and loose debris with a powerful 'air' jet. Helps prevent electronic component errors or downtime.

- Safe for use on all surfaces, electronic components, and sensors
- Does not contain CFC's, HCFC's, and is non-ozone depleting
- Powerful blast easily displaces loose contamination
- Non-flammable & zero odour in use

MATERIALS COMPATIBILITY  
 EVAPORATION RATE  
 CLEANING POWER  
 POST-PROCESS RESIDUE



31570



## AIR DUSTER FG

### FOOD GRADE DUSTER FOR ELECTRONICS

Use to remove loose contaminants from electrical equipment. Ideal for use in flour and spice production facilities.

- NSF K2 registered (N°140256)
- Non-flammable and zero odour in use
- Does not contain CFC's, HCFC's, and is non-ozone depleting
- Zero residue

MATERIALS COMPATIBILITY  
 EVAPORATION RATE  
 CLEANING POWER  
 POST-PROCESS RESIDUE



30253



## INVERTIBLE AIR DUSTER

### "ALL ANGLE" DUSTER FOR ELECTRONICS

A powerful, dry 'air' blast for the removal of dry contaminants from electronics.

- Ideal for safety critical applications
- Invertible valve system virtually eliminates the potential for moisture contamination of delicate electronics
- Non-flammable & zero odour in use
- Zero residue
- Does not contain CFC's, HCFC's, and is non-ozone depleting
- 360° Spray System allows use at all angles

MATERIALS COMPATIBILITY  
 EVAPORATION RATE  
 CLEANING POWER  
 POST-PROCESS RESIDUE



31559



## DUST REMOVER

### NON-SAFETY CRITICAL DUSTER

An economical duster developed to meet the market demand for a non-safety-critical duster.

- Ensure all equipment is de-energised and static electricity has been eliminated prior to use
- Powerful 'air' blast rapidly removes loose contamination
- Ideal for use on delicate electronics
- Does not contain CFC's, HCFC's, and is non-ozone depleting
- Low GWP
- This product is flammable

MATERIALS COMPATIBILITY  
 EVAPORATION RATE  
 CLEANING POWER  
 POST-PROCESS RESIDUE



32504





## DUSTER LO-GWP

### LOW GLOBAL WARMING POTENTIAL DUSTER

A powerful dry air blast for the removal of loose, dry contamination. Formulated to minimise its long-term environmental impact by reducing its global warming potential (GWP) value to just 6.

- Non-flammable (Directive 2008/47/EC)
- Harmless to plastics, coatings and delicate surfaces

#### MATERIALS COMPATIBILITY

EVAPORATION RATE

CLEANING POWER

POST-PROCESS RESIDUE



30104



## ANTI-STATIC SPRAY

### DISSIPATES STATIC BUILD UP

Use on any surface prone to static charge prior to maintenance, or as part of a static control programme.

- Rapidly reduces electrostatic charges
- Quick and easy to use
- Non-toxic and biodegradable
- Particularly useful in the paper and textile industries, and anywhere prone to airborne dust

#### MATERIALS COMPATIBILITY

EVAPORATION RATE

CLEANING POWER

POST-PROCESS RESIDUE



31561



## UNIVERSAL SCREEN CLEANER

### FOAMING VDU SCREEN CLEANER

Removes finger-marks and contamination from visual display units (VDU's) such as LCD monitors, production control screens, and all monitors. Ideal for cleaning thermal imaging camera screens.

- Can be used on most screen types (LCD, TFT, Plasma, etc.)
- Exceptionally economical in use
- NSF P1 registered (N°147407)

#### MATERIALS COMPATIBILITY

EVAPORATION RATE

CLEANING POWER

POST-PROCESS RESIDUE



30236



## LABEL REMOVER

### SELF-ADHESIVE LABEL AND STICKER REMOVER

An optimum blend of solvent and citrus active ingredients penetrate paper labels rapidly.

- Reduces need for scraping and the potential damage that may cause
- Improves packaging line efficiency by reducing jamming caused by label and adhesive build-up
- Pleasant citrus smell
- Test plastics compatibility prior to use

#### MATERIALS COMPATIBILITY

EVAPORATION RATE

CLEANING POWER

POST-PROCESS RESIDUE



31629







## LABEL & ADHESIVE REMOVER FG

**FOOD GRADE LABEL & ADHESIVE REMOVER**  
Use for the removal of packaging and transport labels from shipping containers, plastic boxes, and bulk storage (intermediate) drums.

- NSF K3 registered (N°140259)
- An optimum blend of solvent and citrus active ingredients penetrate paper labels rapidly
- Use on packaging lines to remove label and adhesive build up
- Minimises the requirement for scraping



- MATERIALS COMPATIBILITY
- EVAPORATION RATE
- CLEANING POWER
- POST-PROCESS RESIDUE



## AMBERTRON

### ULTRA PURE CONTACT CLEANER

Ultra pure formulation for critical maintenance. Removes light oils and contamination safely from PCB's, relays, all electrical contacts, switches, and more.

- Excellent materials compatibility: safe for use on plastics, rubber, composites, metal and painted surfaces
- Non-conductive
- Quick and effective cleaning with zero residue
- Automotive approval: Ford Tox No: 166300 and Rail approved: 007/007224
- Will not produce frost



- MATERIALS COMPATIBILITY
- EVAPORATION RATE
- CLEANING POWER
- POST-PROCESS RESIDUE



## NF PRECISION CLEANER

### NON-FLAMMABLE CONTACT CLEANER

An advanced solvent contact cleaner that is non-flammable and ideal for servicing critical electronics that cannot be switched off or de-energised.

- Excellent materials compatibility: safe for use on plastics, rubber, composites, metal and painted surfaces
- Passes flame extension test FEA 607E and Drum test FEA 610E for genuine non-flammable performance
- High Dielectric strength: 17kV



- MATERIALS COMPATIBILITY
- EVAPORATION RATE
- CLEANING POWER
- POST-PROCESS RESIDUE



## CONTACT CLEANER FG

### FOOD GRADE ELECTRICAL CONTACT CLEANER

Designed for electrical component maintenance in the food industry, particularly for on-line production electrics and similar delicate equipment.

- NSF K2 Registered (N°139627)
- Use to remove grime and contamination from PCB's and electronics
- Reduces voltage drop due to contamination
- Non-corrosive and non-conductive



- MATERIALS COMPATIBILITY
- EVAPORATION RATE
- CLEANING POWER
- POST-PROCESS RESIDUE





## IPA SOLVENT

### ISOPROPYL ALCOHOL CLEANING SOLVENT

A gentle yet highly effective alcohol based cleaner for use on optical devices, switches, PCB's and on general electronics.

- Excellent materials compatibility: safe for use on plastics, rubber, composites, metal and painted surfaces
- Conforms to BS 1595, ASTM D770, and DIN 53245
- Zero residue

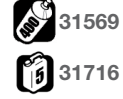

MATERIALS COMPATIBILITY  
 EVAPORATION RATE  
 CLEANING POWER  
 POST-PROCESS RESIDUE



## PCB CLEANER

### ELECTRONICS CLEANING SOLVENT

Removes light soiling from PCB's in a wide range of electrical and electronic equipment.

- Exhibits enhanced solvency power over a standard contact cleaner for removal of light contamination accumulation from PCB boards and other electronic components.
- Excellent materials compatibility: safe for use on plastics, rubber, composites, metal and painted surfaces



MATERIALS COMPATIBILITY  
 EVAPORATION RATE  
 CLEANING POWER  
 POST-PROCESS RESIDUE



## FLUX REMOVER

### FLUX REMOVER AND DEGREASER

Removes flux residues after electronic component repair. The bespoke formulation allows the solvent blend to penetrate contamination rapidly, and leaves a residue free surface.

- Removes both organic and non-organic fluxes and residues from PCB's
- Excellent materials compatibility: safe for use on plastics, rubber, composites, metal and painted surfaces



MATERIALS COMPATIBILITY  
 EVAPORATION RATE  
 CLEANING POWER  
 POST-PROCESS RESIDUE



## CCL 100

### 2-IN-1 CONTACT CLEANER LUBRICANT

A versatile product for use on electrical switchgear and electric motor contacts. Ideal for use on radar systems where contacts may be exposed to moisture.

- Cleans, lubricates, and prevents corrosion in one application
- Removes light oils, light grease, tarnish, and oxidation
- Cuts voltage drop between contacts
- Leaves an oily conductive film for contact protection



MATERIALS COMPATIBILITY  
 EVAPORATION RATE  
 CLEANING POWER  
 FILM VISCOSITY



## ULTRASONIC CLEANING FLUID

### GENERAL PURPOSE CLEANER

Suitable for use in ultrasonic baths, this cleaner removes all traces of contamination including oils, waxes, fluxes, and silicones.

- Can be diluted 5:1 depending on level of soiling
- Effective in both hot and cold water

#### MATERIALS COMPATIBILITY



#### EVAPORATION RATE



#### CLEANING POWER



#### POST-PROCESS RESIDUE



32112

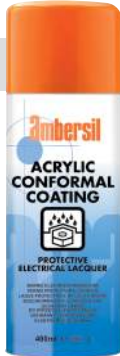

## ACRYLIC CONFORMAL COATING

### PROTECTION FOR PCB'S

Apply to populated PCB's and electronics to seal out moisture and dust for long-term protection.

- Transparent insulating conformal coating
- Wets out to form a homogenous film with uniform thickness
- Cured lacquer is flexible, will not crack or chip and can be soldered through

#### DRIED FILM HARDNESS



#### LONGEVITY



#### PROTECTION



#### FLEXIBILITY



30235



32057



## SV100

### ANTI-TRACKING INSULATING VARNISH

Specifically developed to protect electric motors.

- Insulates and protects all types of electrical systems against high humidity
- Highly visible red varnish
- Dries rapidly: touch dry in 15 minutes, handling time in 40 minutes, and full cure within 48 hours
- When cured, the film conforms to BS 5629 type 1.1

#### DRIED FILM HARDNESS



#### LONGEVITY



#### PROTECTION



#### FLEXIBILITY



31892



## FREEZER

### FAULT DETECTION FOR ELECTRONICS

Use on electronic circuits to identify thermally intermittent faulty components.

- Rapidly reduces component temperature by up to -50°C
- Non-flammable, non-toxic, and completely odourless
- Can be used to cool thermally sensitive parts during soldering or calibration
- Rail Approved product (007/020505)

#### MATERIALS COMPATIBILITY



#### EVAPORATION RATE



#### CLEANING POWER

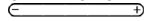

#### POST-PROCESS RESIDUE

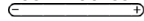

31562





# LUBRICANTS, GREASES & OILS

From multi-purpose lubricants through to fully synthetic gear oils, Ambersil lubricants keep the wheels of industry turning

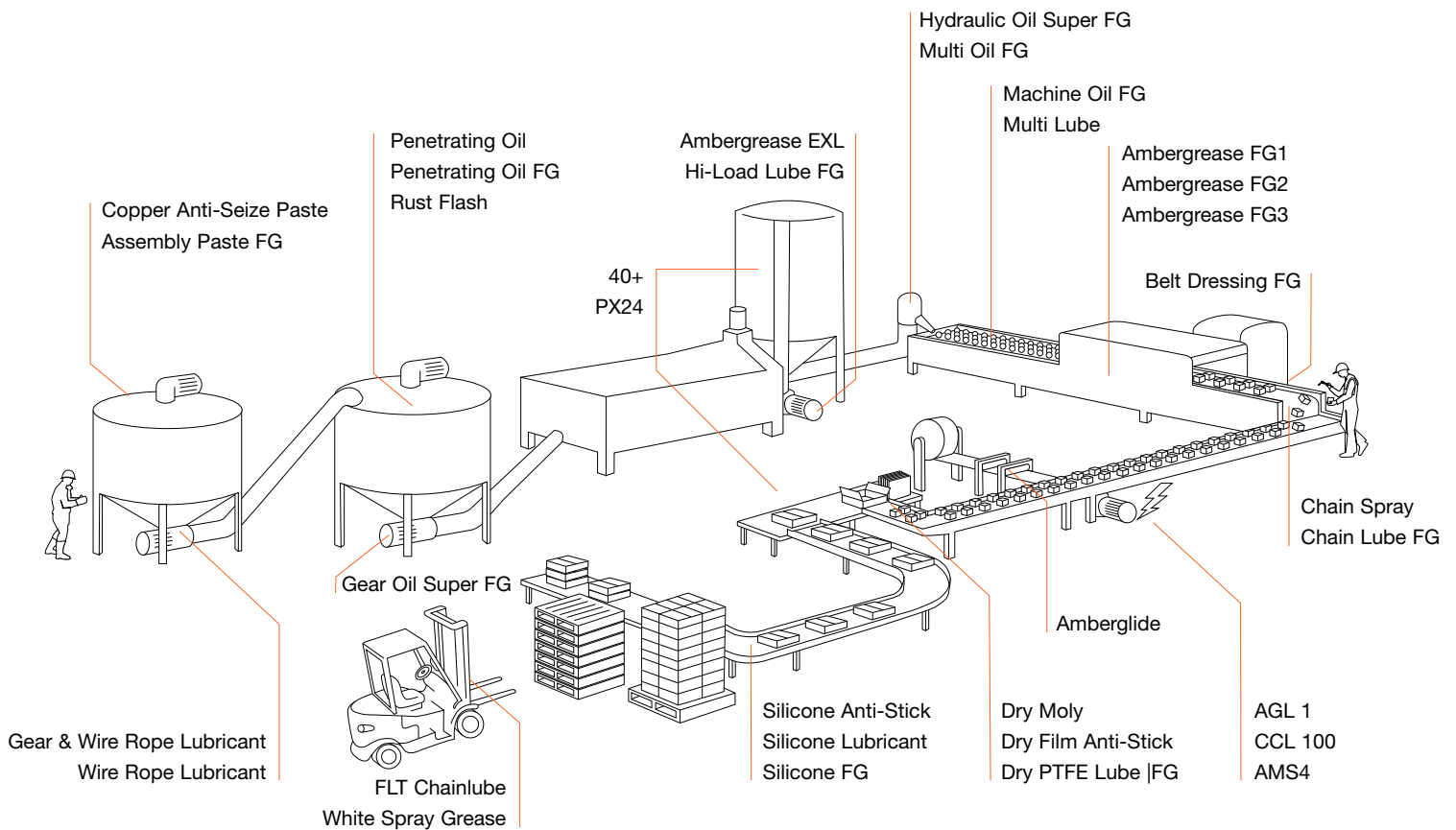



# Lubricants Selection Chart

Product Type	Application Requirement	Type of Duty	Recommended Product	Page
<b>Multi-Purpose</b>	Military Grade		➔ PX24	30
	Food Processing Safe®		➔ MACHINE OIL FG	30
	Multiple Industrial Approvals		➔ 40+	30
	General Purpose		➔ MULTI-LUBE	31
	Greaseless/Thin-Film		➔ AGL1	31
<b>PTFE Lubricants</b>	Wet-Film	Oily	➔ AMBERGLIDE	33
		Chain Lubricant	➔ CHAIN LUBE FG	35
	Dry Film		➔ DRY FILM ANTI-STICK	33
		Food Processing Safe®	➔ DRY PTFE LUBE FG	33
<b>Silicone Lubricants</b>	Grease		➔ AMS4 SILICONE GREASE	38
	High Concentration Silicone		➔ SILICONE ANTI-STICK	32
	General Purpose Silicone		➔ SILICONE LUBRICANT	32
	Food Processing Safe®		➔ SILICONE FG	32
<b>MoS2 Lubricants</b>	Dry Film Lubricant	Resin Bonded	➔ DRY MOLY	33
<b>Greases</b>	Top-Line Performance Grease	>800Kg 4-ball weld	➔ AMBERGREASE EXL	36
	Food Processing Safe®: Hi-Load	400Kg 4-ball weld	➔ HI-LOAD LUBE FG	37
	Food Processing Safe®: General Purpose	200Kg 4-ball weld	➔ AMBERGREASE FG1	36
	Food Processing Safe®: High Temp	180Kg 4-Ball weld	➔ AMBERGREASE FG2	36
	Food Processing Safe®: General Purpose	120Kg 4-Ball weld	➔ AMBERGREASE FG3	37
			➔ FOOD GREASE FG	37
	Electronics Grease		➔ AMBERGREASE SII	38
		XG-250	➔ AMS4	38
	General Automotive Grease		➔ WHITE SPRAY GREASE	37
	NLGI 00		➔ WIRE ROPE LUBE	35
<b>Anti-Seize &amp; Penetrating Oils</b>	General Purpose Anti-Seize		➔ COPPER ANTI-SEIZE	34
	Food Grade Anti-Seize		➔ ASSEMBLY PASTE FG	34
	Traditional, Penetrating Oil (with MoS2)		➔ PENETRATING OIL	31
		Food Processing Safe®	➔ PENETRATING OIL FG	31
	Freeze Shock Penetrating Oil		➔ RUST FLASH	32
<b>Chains, Gears, Wire Rope, Drive &amp; Belt Lubricants</b>	Heavy Duty Chain Lubricant	MoS2	➔ CHAINSPRAY	34
		Fork Lift Trucks	➔ FLT CHAIN SPRAY	34
		Food Processing Safe®	➔ CHAIN LUBE FG	35
	Open Gears & Drives		➔ GEAR & WIRE ROPE LUBE	34
	Wire Ropes	Aerosol	➔ GEAR & WIRE ROPE LUBE	34
		Bulk Grease	➔ WIRE ROBE LUBRICANT	35
	Drive Belts & Conveyors		➔ BELT DRESSING FG	35
<b>Bulk Oils (Gear, Hydraulic &amp; Multi Oil)</b>			➔ GEAR OIL SUPER 320 FG	39
			➔ GEAR OIL SUPER 220 FG	39
			➔ GEAR OIL SUPER 150 FG	39
			➔ SILICONE OIL	38
			➔ HYDRAULIC OIL SUPER 68 FG	39
			➔ HYDRAULIC OIL SUPER 46 FG	39
			➔ MULTI-OIL 46 FG	40
			➔ HYDRAULIC OIL SUPER 32 FG	39
	➔ MULTI-OIL 32 FG	40		



## 40+

### THE COMPLETE MAINTENANCE TREATMENT

A true multi-purpose 'cure-all' for engineers: use as a dewatering fluid, a penetrant on seized fasteners, a general lubricant, and as a corrosion inhibitor.

- Excellent water displacement performance
- High di-electric strength, non-conductive film
- Safe on most paints, plastics, rubbers, and all metals
- Operational temperature range: -20°C to +115°C

MATERIALS COMPATIBILITY

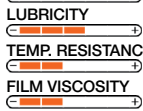

- 32400
- 31532
- 31712

- 31563
- 31711



## PX24

### MILITARY GRADE PROTECTIVE LUBRICANT

Exceptional multi-purpose lubricant formulated to military specifications. It offers excellent materials compatibility, good lubrication as a machine oil, total moisture displacement and medium-term corrosion protection.

- Meets military specification Def. Stan 68-10 Issue 5 PX24
- Zero copper corrosion: IP 154, max 1: no pitting or etching
- Operational temperature range: -20°C to +115°C
- Rolls Royce Aerospace Approved: 1042E
- AgustaWestland approved: WHPS: 158
- Fitted with a 360° Spray System for all angle use

MATERIALS COMPATIBILITY

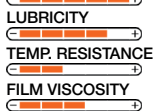

- 31565
- 31706

- 31705
- 31707



## MOISTURE REMOVER FG

### NSF REGISTERED DEWATERING FLUID

For use on equipment to displace moisture, particularly after wash-down. Ideal for use on electronics.

- NSF H2 registered (N°142299)
- Prevents corrosion by displacing water from affected areas
- Provides precision lubrication with its thin, high dielectric strength lubricating film
- Operational Temperature range: -50°C to +120°C

MATERIALS COMPATIBILITY

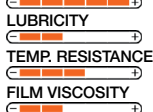

- 30260



## MACHINE OIL FG

### NSF H1 GENERAL PURPOSE LUBRICANT

For use in the food industry as a highly effective metal-to-metal lubricating film.

- NSF H1 registered (No°137999 & 140249)
- Formulated using only food grade acceptable components
- Creates a highly effective lubricating and anti-friction film
- Can be used as an anti-corrosion coating for metal parts in high humidity conditions
- Operational temperature range: -18°C to +120°C

MATERIALS COMPATIBILITY

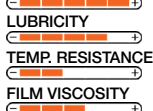

- 30247

- 30255





## MULTI-LUBE

### MULTI-PURPOSE LUBRICANT

A versatile light lubricant for use by automotive professionals and the maintenance of mechanical handling equipment.

- Use as a lubricant, penetrant, anti-corrosion spray or dewatering fluid
- Safe on most paints, plastics, rubbers, and all metals
- Operational temperature range: -20°C to +115°C
- Good water displacement properties

MATERIALS COMPATIBILITY

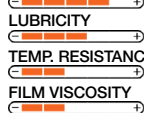

31615



## AGL 1

### LUBRICANT FOR ELECTRICAL EQUIPMENT

Use to displace moisture and protect electrical contacts from corrosion.

- Ideal for renovating water-damaged equipment and motors
- Provides precision lubrication with its thin, high dielectric strength lubricating film
- Cleans, lubricates and protects all in one application

MATERIALS COMPATIBILITY

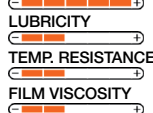

31567



## PENETRATING OIL

### PENETRANT FOR SEIZED PARTS

Use as a highly effective release agent for all types of seized fasteners.

- Quickly frees fasteners seized by corrosion, heat, and over tightening
- Lubricates fine and close tolerance threads
- Contains MoS<sub>2</sub>
- Facilitates easier disassembly & reassembly
- Softens rust and carbon deposits

MATERIALS COMPATIBILITY

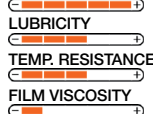

30240



## PENETRATING OIL FG

### FOOD GRADE PENETRATING OIL

For use in the food & beverage industry on fasteners seized by heat, corrosion, over-tightening and contamination.

- NSF H1 registered (N°140260)
- Spray on, allow to penetrate, and remove seized fasteners without damaging the head, thread or risk shearing
- Does not contain silicone
- Safe for use on all metals

MATERIALS COMPATIBILITY



30256







## RUST FLASH

### PENETRANT WITH FREEZE SHOCK ACTION

For use on all seized and corroded fasteners. Ideal for bolts on equipment located outside and subjected to adverse conditions.

- Utilises the laws of thermo-dynamics: shock rust down to -40C
- The rapid temperature drop causes the rust to fracture, allowing the lubricating oils to penetrate faster

MATERIALS COMPATIBILITY

- LUBRICITY
- TEMP. RESISTANCE
- FILM VISCOSITY



31578



## SILICONE LUBRICANT

### GENERAL PURPOSE SILICONE LUBRICANT

Use for plastic-to-plastic lubrication and as a highly effective friction inhibitor on chutes and slides. Ideal for use on tight plastic pipe fittings, or as a cutting aid on paper/textile blades.

- Odourless, colourless and non-staining
- Non-toxic and safe for use with potable water systems
- Exhibits excellent slip properties on blades, tables, chutes and conveyor guides
- Operational temperature range: -50°C to +200°C
- WRAS approved product: 0311521

MATERIALS COMPATIBILITY

- LUBRICITY
- TEMP. RESISTANCE
- FILM VISCOSITY



31631



WRAS APPROVED PRODUCT



## SILICONE ANTI-STICK

### CONCENTRATED SILICONE LUBRICANT

High concentration silicone lubricant for demanding applications with higher loads or increased speeds e.g. robotic picking lines, pallet conveyors guides, and close tolerance fitting of large bore water pipes.

- Odourless, colourless and non-staining
- Use where high standards of purity and performance are essential
- Helps prevent line jams and inhibits adhesive build up on blades and sealers
- Operational temperature range: -50°C to +200°C

MATERIALS COMPATIBILITY

- LUBRICITY
- TEMP. RESISTANCE
- FILM VISCOSITY



31572



WRAS APPROVED PRODUCT



## SILICONE FG

### NSF H1 REGISTERED SILICONE LUBRICANT

Use where friction reduction is required particularly plastic-to-plastic components, on guide rails or as a label adhesive anti-stick treatment to dramatically reduce label adhesive build-up.

- NSF H1 registered (N°138000)
- Excellent general lubrication with a relatively dry film
- Eliminates sticking, squeaking and binding
- Operational temperature range: -40°C to +200°C
- Use on high-speed bagging lines and on chutes/slides

MATERIALS COMPATIBILITY

- LUBRICITY
- TEMP. RESISTANCE
- FILM VISCOSITY



30248





## AMBERGLIDE

### CONCENTRATED PTFE LUBRICANT

A general purpose lubricating oil fortified with high levels of PTFE for exceptional lubrication and anti-friction properties.

- Provides a long-lasting and durable film
- Significantly increases re-lubrication intervals
- Operational Temperature range: -10°C to +180°C
- Highly water resistant and repels water from treated areas

MATERIALS COMPATIBILITY

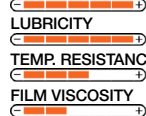

31571



## DRY FILM ANTI-STICK

### CONCENTRATED DRY PTFE LUBRICANT

A concentrated, high PTFE content dry film lubricant for the lubrication of moving parts where an oily/wet or silicone lubricant cannot be used.

- The high level of PTFE in the dry film provides excellent anti-friction and slip performance to all sliding surfaces
- Excellent materials compatibility
- Suitable for use as an anti-tracking agent
- The dry film is unaffected by oil or solvents
- Operational Temperature range: -100°C to +200°C

MATERIALS COMPATIBILITY

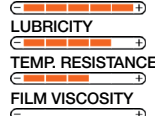

31573



## DRY PTFE LUBE FG

### NSF H1 REGISTERED DRY LUBRICANT

A fine, dry PTFE lubricant for the general lubrication of moving parts where an oily or silicone lubricant cannot be used.

- NSF H1 registered (N°139899).
- Excellent materials compatibility
- Deposits a dry, non-staining film of pure PTFE
- The dry film is unaffected by oil and solvents
- Operational Temperature range: -100°C to +200°C

MATERIALS COMPATIBILITY

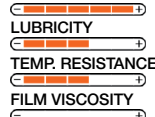

31589



## DRY MOLY

### DRY MOLYBDENUM DISULPHIDE LUBRICANT

For use in high load applications where other lubricants would fail, but a dry film is still required. Use as a running in treatment on rolling and sliding bearings.

- Tough and long lasting resin bonded lubricant
- Multiple applications (recoating) provide enhanced performance, with the final coat benefitting from light polishing to further improve slip.
- Operational Temperature range: -150°C to +400°C

MATERIALS COMPATIBILITY

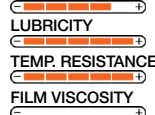

31576







## COPPER ANTI-SEIZE PASTE

### HIGH TEMPERATURE ANTI-SEIZE

Use on threaded fasteners to prevent seizing during prolonged maintenance intervals, in hostile/high humidity environments, and areas subjected to high temperatures.

- Formulated with micronized copper and anti-oxidant additives to reduce friction and wear. Lead & Nickel free
- Good corrosion protection even in highly corrosive environments
- Operational Temperature range: -30°C to +1100°C

MATERIALS COMPATIBILITY

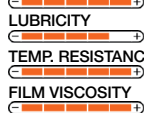

## ASSEMBLY PASTE FG

### ANTI-SEIZE & ASSEMBLY COMPOUND

Use in the same manner as a traditional Copper Anti-Seize on fasteners, or as a running-in compound for bearings. The non-metallic solids content make this product suitable for use in the food industry.

- NSF H1 registered (N°138266 & 139900)
- Prevents seizure of threaded components enabling easy and quick dismantling
- Operational Temperature range: -30°C to +1100°C

MATERIALS COMPATIBILITY

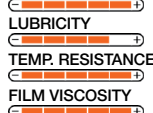

## GEAR & WIRE ROPE LUBRICANT

### HEAVY DUTY LUBRICANT

Specially formulated for open gears in dusty environments (e.g. quarries) where the semi-dry film does not attract or hold dust. Use on all wire ropes subjected to tension and/or movement.

- Forms a semi-dry, non-peeling film that overcomes the limitations of grease and pressure cushions
- Can be applied to gears in motion
- Deep penetration of wire ropes for internal lubrication and corrosion protection
- Operational Temperature range: -25°C to +100°C

MATERIALS COMPATIBILITY

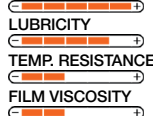

## CHAINS PRAY

### CHAIN & DRIVE LUBRICANT

Use on all types of drive chains, including production line, door mechanisms, quarry plant, and drying oven doors.

- Offers maximum adhesion to chain link with excellent penetration, lubrication and corrosion protection of the pins
- High temperature resistant: up to 200°C continuous (300°C intermittent)
- Also available as an alternative product specifically for use on fork lift trucks: "FLT Chain Spray"

MATERIALS COMPATIBILITY

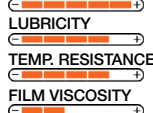



## CHAIN LUBE FG

### FOOD GRADE PTFE CHAIN LUBRICANT

Ideal for all types of chains and chain driven drive systems. The addition of PTFE to the lubricant enhances long-term chain lubrication.

- NSF H1 registered (N°137998 & 143144)
- Gentle foaming action helps lubricant cling to chains and penetrate deep into links
- Leaves a tenacious, long lasting lubricating and anti-corrosion film
- Operational Temperature range: -15°C to +175°C

MATERIALS COMPATIBILITY

LUBRICITY

TEMP. RESISTANCE

FILM VISCOSITY



## WIRE ROPE LUBRICANT

### SEMI-FLUID WIRE ROPE GREASE

Designed for the lubrication and corrosion prevention requirements of wire ropes working under all conditions, particularly marine environments.

- Penetrates between the rope strands to provide internal lubrication and protection
- High solids content protects wire rope strands from high load and wear during service life
- NLGI grade 00



MATERIALS COMPATIBILITY

LUBRICITY

TEMP. RESISTANCE

FILM VISCOSITY



## BELT DRESSING FG

### ADHESIVE BELT LUBRICANT

Improves grip on all types of belts whilst reducing squeak and prolongs belt service life.

- NSF H1 registered (N°140257)
- Works on all types of belts: vee, flat, toothed, rubber, leather and fabric
- Protects belt from deterioration through oxidation and heat
- Tacky lubricating film increases belt pulling power and does not fling off



MATERIALS COMPATIBILITY

LUBRICITY

TEMP. RESISTANCE

FILM VISCOSITY



## BLUE ADHESIVE LUBRICANT

### ADVANCED MULTI-PURPOSE LUBRICANT

A specially formulated blend of high quality mineral and synthetic oils, anti-oxidation and anti-wear additives, friction modifiers and tackiness agents.

- Penetrates upon application then thickens
- Ideal for applications where shock loading occurs
- Highly visible blue colour upon application for visible coverage, which then turns transparent after a few days
- Temperature range: -12°C to +150°C (180°C intermittent)



MATERIALS COMPATIBILITY

LUBRICITY

TEMP. RESISTANCE

FILM VISCOSITY







## GRAPHITE RELEASE SPRAY

### DRY GRAPHITE LUBRICANT & RELEASE SPRAY

A high purity, dry, concentrated graphite lubricant and release agent. Formulated especially for the glass blowing industry as a mould pre-treatment.

- The resin binder allows the micro-graphite particles to bind strongly to all substrates
- Above 100°C the binder will safely decompose leaving dry graphite powder for the highly effective and consistent release of formed glass bottles

MATERIALS COMPATIBILITY

LUBRICITY

TEMP. RESISTANCE

FILM VISCOSITY



32499



## AMBERGREASE EXL

### EXTENDED LIFE, PERFORMANCE BEARING GREASE

Use on critical, high load bearings and sliding surfaces. Ideal for use in applications where a longer than usual in-service life is required.

- Exceptional load carrying capacity: >800Kg 4-ball weld load
- Mean Hertz Load: 125Kg; Timken OK load: 25Kg
- Highly visible red grease, NLGI type 2, Lithium-Calcium Complex thickened
- Operational Temperature range: -30°C to +150°C

MATERIALS COMPATIBILITY

4-BALL WELD

TEMP. RESISTANCE

NLGI GRADE



30304

5kg 31574



## AMBERGREASE FG1

### FOOD GRADE PERFORMANCE GREASE

A high performance multi-purpose grease suitable for all bearing types and use at low temperatures. It demonstrates enhanced performance characteristics in moist or wet environments.

- NSF H1 Registered (N°138264)
- White, NLGI type 2, aluminium complex thickened grease
- Very good load performance: 4-ball weld load >200Kg
- Very low water-washout <1%
- Operational Temperature range: -50°C to +165°C

MATERIALS COMPATIBILITY

4-BALL WELD

TEMP. RESISTANCE

NLGI GRADE

FOOD PROCESSING SAFE

NSF



31584

18kg 32451



## AMBERGREASE FG2

### HIGH TEMPERATURE BEARING GREASE

For use in the food/beverage industry on all types of plain bearings subjected to elevated temperatures such as on oven conveyors, oven fan bearings, bakery lines, autoclaves, and food container moulding machines.

- NSF H1 registered (N°138265)
- Translucent NLGI type 2 silicone grease
- Shell 4-ball weld load (IP 239): 180Kg
- Operational Temperature range: -20°C to +220°C

MATERIALS COMPATIBILITY

4-BALL WELD

TEMP. RESISTANCE

NLGI GRADE

FOOD PROCESSING SAFE

NSF



31585







30258



## AMBERGREASE FG3

### NSF H1 MULTI-PURPOSE BEARING GREASE

A multi-purpose grease that is ideally suited to general bearing lubrication not subjected to extremes of operating requirements.

- NSF H1 registered (N°140248)
- NLGI type 2, translucent grease; aluminium complex thickened
- Ideal for end-of-line conveyor lubrication and low-load drive motor bearings
- Operational Temperature range: -20°C to +140°C



MATERIALS COMPATIBILITY

4-BALL WELD

TEMP. RESISTANCE

NLGI GRADE



31966

18kg 32508



## HI-LOAD LUBE FG

### NSF H1 HEAVY DUTY BEARING GREASE

Use on heavily loaded bearings and sliding surfaces (e.g. guide rails) to minimise friction and wear.

- NSF H1 registered (N°143048)
- Excellent load-bearing: 4-ball weld load >400Kg
- Excellent moisture resistance with very low water washout
- NLGI type 2, white, aluminium complex thickened grease
- Operational Temperature range: -40°C to +180°C
- Available in 18Kg as "Grease EP2"



MATERIALS COMPATIBILITY

4-BALL WELD

TEMP. RESISTANCE

NLGI GRADE



30259



## FOOD GREASE FG

### MULTI-PURPOSE SPRAY GREASE

Formulated for use in the food and beverage industry on plain bearings, hinges and moving parts. Particularly for limited access areas where regular grease penetration may be difficult.

- NSF H1 registered (N°140258)
- NLGI type 2 white grease, aluminium complex thickened
- Excellent resistance to moisture with very low water wash-out
- Operational Temperature range: -20°C to +140°C



MATERIALS COMPATIBILITY

4-BALL WELD

TEMP. RESISTANCE

NLGI GRADE



31617



## WHITE SPRAY GREASE

### MULTI-PURPOSE SPRAY GREASE

Ideal for use on vehicle door hinges, on runners, guides, and for assembly of close tolerance parts.

- Multi-purpose white grease in an aerosol
- Good penetration for even coverage and protection
- Operational Temperature range: -10°C to +120°C



MATERIALS COMPATIBILITY

LUBRICITY

TEMP. RESISTANCE

FILM VISCOSITY



## AMBERGREASE SIL

### PURE SILICONE GREASE

Ideal for electric motor spindle lubrication or to protect electronics from atmospheric moisture.

- Clear, colourless, odourless NLGI type 2 grease
- Suitable for waterproofing all types of electrical systems
- Excellent dielectric resistance
- 4-ball weld load of 200Kg
- Operational Temperature range: -50°C to +220°C



MATERIALS COMPATIBILITY

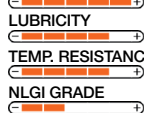

## AMS4 SILICONE GREASE

### MILITARY GRADE SILICONE GREASE

Military & aviation grade XG250 silicone grease for use on rubber seals to prevent cracking, on 3-phase connectors to prevent moisture ingress and for general lubrication.

- Insulates high voltage parts against leaking and arcing
- Waterproofs electronics in damp or humid conditions
- Meets military and aviation specifications: Def. Stan 68-91/1



MATERIALS COMPATIBILITY

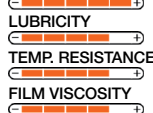

## 3H OIL FG

### FOOD CONTACT OIL

3H Oil FG is a lubricating and release oil that can be used in applications where direct food contact is likely or certain. The light oil can be used as an anti-corrosion treatment on metal surfaces, tools, and equipment, as a release agent on bakery tins & moulds or as a light lubricant for mixing blades.

- NSF 3H & H1 registered (N°148343)
- Light oil seals out moisture and helps prevent corrosion
- Non-tainting, non-staining and clear
- Operational temperature range: -5°C to +120°C



MATERIALS COMPATIBILITY



## SILICONE OIL

### PURE SILICONE OIL

A clear, odourless, pure silicone oil for a wide range of anti-stick and anti-friction applications where a highly concentrated silicone oil is required.

- Pure silicone oil with a viscosity of 100 Cst
- Non-flammable, non-toxic, and chemically stable
- Odourless, colourless and non-staining
- Safe on most paints, plastics, rubbers, and all metals
- Exhibits excellent slip properties
- Operational Temperature range: -40°C to +200°C



MATERIALS COMPATIBILITY



# HYDRAULIC OIL SUPER 32/46/68 FG



A series of transparent, odourless, fully synthetic hydraulic fluids based on Poly Alpha Olefins (PAO) for use in the food & beverage sector. These oils have extremely stable operating characteristics with a wide temperature range, foaming suppression, friction/wear reduction, and moisture rejection. Passes DIN 51524/T2 standard for hydraulic fluids. Can be used as a compressor oil (ISO 32).



## Hydraulic Oil Super 32 FG

NSF H1 registered: N°142717

Viscosity @ 40°C: ISO 32

Temperature Stability: Viscosity Index: 142

Temperature Range: -57°C to +238°C



30265



30266

### MATERIALS COMPATIBILITY

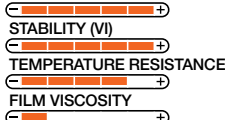

## Hydraulic Oil Super 46 FG

N°142716

ISO 46

Viscosity Index: 145

-57°C to +252°C



30267



30268

### MATERIALS COMPATIBILITY

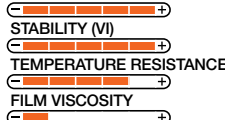

## Hydraulic Oil Super 68 FG

N°142714

ISO 68

Viscosity Index: 141

-57°C to +260°C



30270



30271

### MATERIALS COMPATIBILITY

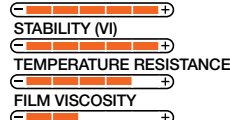

# GEAR OIL SUPER 150/220/320 FG



A series of transparent, odourless, fully synthetic gear oils based on Poly Alpha Olefins (PAO) with a complex performance additive package for use in the food & beverage sector. These oils have extremely stable operating characteristics with a wide temperature range, foaming suppression, excellent friction/wear reduction (even highly loaded gears), and moisture rejection.

These gear oils provide high EP and anti-wear performance, meet the DIN 51 517 standard, and exhibit extremely wide temperature range stability. Ideal for gear boxes with extended service intervals.



## Gear Oil Super 150 FG

NSF H1 registered: N°142715

Viscosity @ 40°C: ISO 150

Temperature Stability: Viscosity Index: 137

Temperature Range: -56°C to +256°C



30272



30273

### MATERIALS COMPATIBILITY

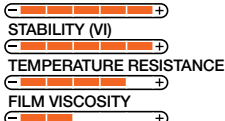

## Gear Oil Super 220 FG

N°142721

ISO 220

Viscosity Index: 140

-51°C to +258°C



30274



30275

### MATERIALS COMPATIBILITY

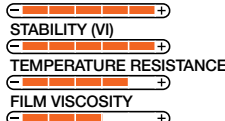

## Gear Oil Super 320 FG

N°142720

ISO 320

Viscosity Index: 142

-48°C to +264°C



30276



30277

### MATERIALS COMPATIBILITY

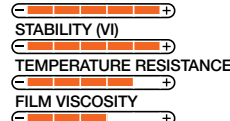



## MULTI OIL 32/46 FG



General purpose highly refined white oils for use in multiple applications such as in selected hydraulic systems, as a medium viscosity lubricating film and as a light duty anti-corrosion coating.

	Multi Oil 32 FG	Multi Oil 46 FG
NSF H1 Reg:	N°142719	N°142718
Viscosity @ 40°C:	ISO 32	ISO 46
Viscosity Index:	105	105
Temperature range:	-21°C to +170°C	-21°C to +180°C



MATERIALS COMPATIBILITY	MATERIALS COMPATIBILITY
STABILITY (VI)	STABILITY (VI)
TEMPERATURE RESISTANCE	TEMPERATURE RESISTANCE
FILM VISCOSITY	FILM VISCOSITY

## LUBRICATING OIL 'LO' 32/68/100



A multi-purpose, semi-synthetic lubricating oil for the food and drink industry. NSF H1 registered for use where incidental food contact may occur. This oil is formulated with highly refined medicinal oils and special additives. It can be used as a hydraulic oil, a compressor oil, a general lubricating oil or as a light anti-corrosion coating.

	LO 32 FG	LO 68 FG	LO 100 FG
NSF H1 Reg:	N°143789	N°143794	N°143788
Viscosity @ 40°C:	ISO 32	ISO 68	ISO 100
Viscosity Index:	105	105	V105
Temperature range:	-21°C to +170°C	-21°C to +200°C	-18°C to +215°C



MATERIALS COMPATIBILITY	MATERIALS COMPATIBILITY	MATERIALS COMPATIBILITY
STABILITY (VI)	STABILITY (VI)	STABILITY (VI)
TEMPERATURE RESISTANCE	TEMPERATURE RESISTANCE	TEMPERATURE RESISTANCE
FILM VISCOSITY	FILM VISCOSITY	FILM VISCOSITY

# STOPLIGHT™ – CHEMICAL CONTROL THROUGH COLOUR CODING

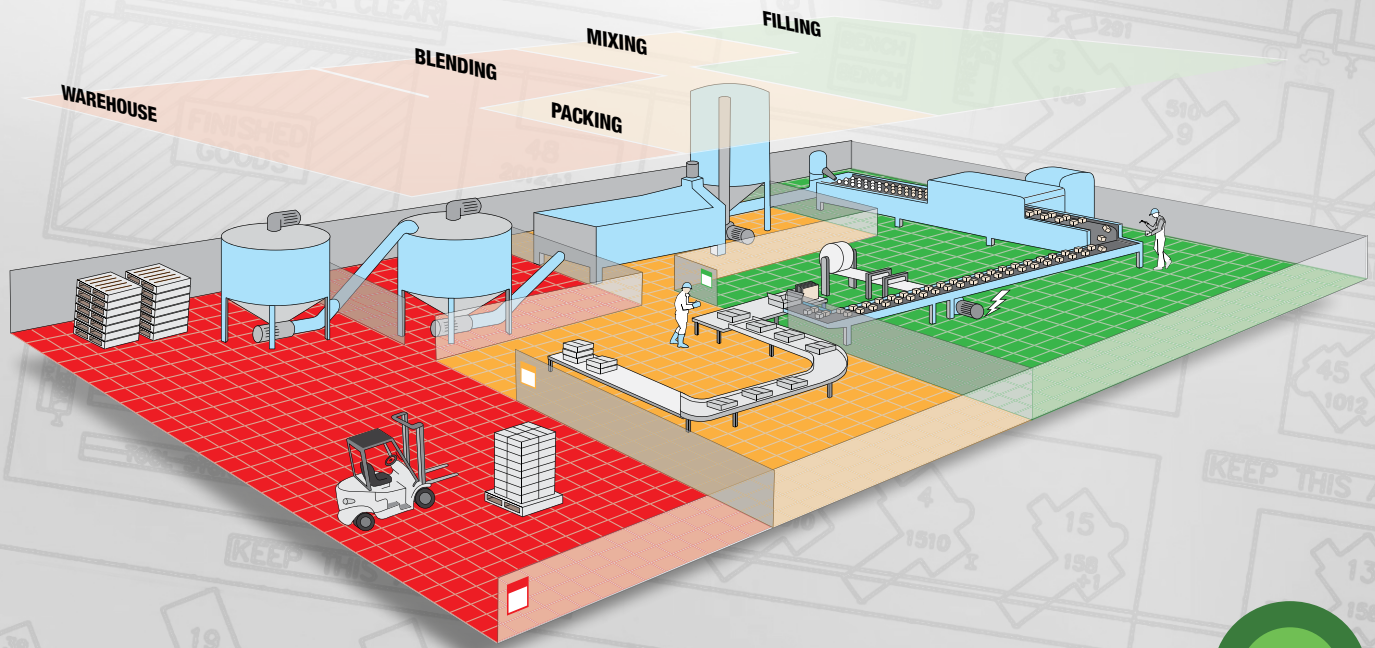

## STOPLIGHT™ Chemical Control Through Colour Coding

### Audit compliant

Elements of the common supermarket and BRC audits already call for maintenance chemical control; StopLight™ takes these criteria and offers a verifiable solution for the audit check-list.

### Accessible

StopLight™ is accessible to all users, regardless of native language. Colour coding is widely understood and is highly visible. For users who have limited colour vision, all signs contain the product name (which is not language-dependent) as well as displaying the zone colour in multi-language texts.

### Product choice

StopLight™ has been developed to be used alongside the comprehensive Ambersil range of products. However, StopLight™ will work with any chemical brands should an equivalent Ambersil product not be available.

### Totally flexible

StopLight™ can be implemented in any facility that requires maintenance chemical control. Not just the food/beverage/pharma industries.

### Easy to understand and set-up

StopLight™ is based on well understood concepts such as HACCP, zoning and colour coding.



# METAL WORKING

Created for the most demanding metal working applications where 'right first time' results are required





# Metal Working Selection Chart

Product Type	Application Requirement	Type of Duty	Recommended Product	Page
<b>Metal Working</b>	CNC & Automated Equipment		<b>TUFCUT AQUA</b>	44
	High Carbon Steels & 'Tough' Metal		<b>TUFCUT SPRAY</b>	44
		— Foaming	<b>TUFCUT FOAM</b>	44
		— Traditional Liquid	<b>TUFCUT LIQUID</b>	44
	Titanium		<b>TUFCUT FOAM</b>	44
	Aluminium & 'Soft' Metals		<b>TUFCUT SPRAY</b>	44
		— Foaming	<b>TUFCUT FOAM</b>	44
		— Traditional Liquid	<b>TUFCUT LIQUID</b>	44
		— Thick Paste	<b>TUFCUT COMPOUND</b>	44
	Composites (e.g. Carbon Fibre) (Food Processing Safe®)		<b>TUFCUT LIQUID</b>	44
		<b>TUFCUT SPRAY</b>	44	
<b>Welding</b>	Anti-Spatter	— Traditional	<b>SPATTER RELEASE</b>	44
		— Solvent Based	<b>EASY WELD</b>	45
		— Water Based	<b>BIOWELD</b>	45
		— Biodegradable	<b>EASY WELD</b>	45
<b>Flaw Detection</b>	Dye Penetrant System		<b>FLAW DETECTORS</b>	45
	Leak Detection		<b>LEAK DETECTOR</b>	45

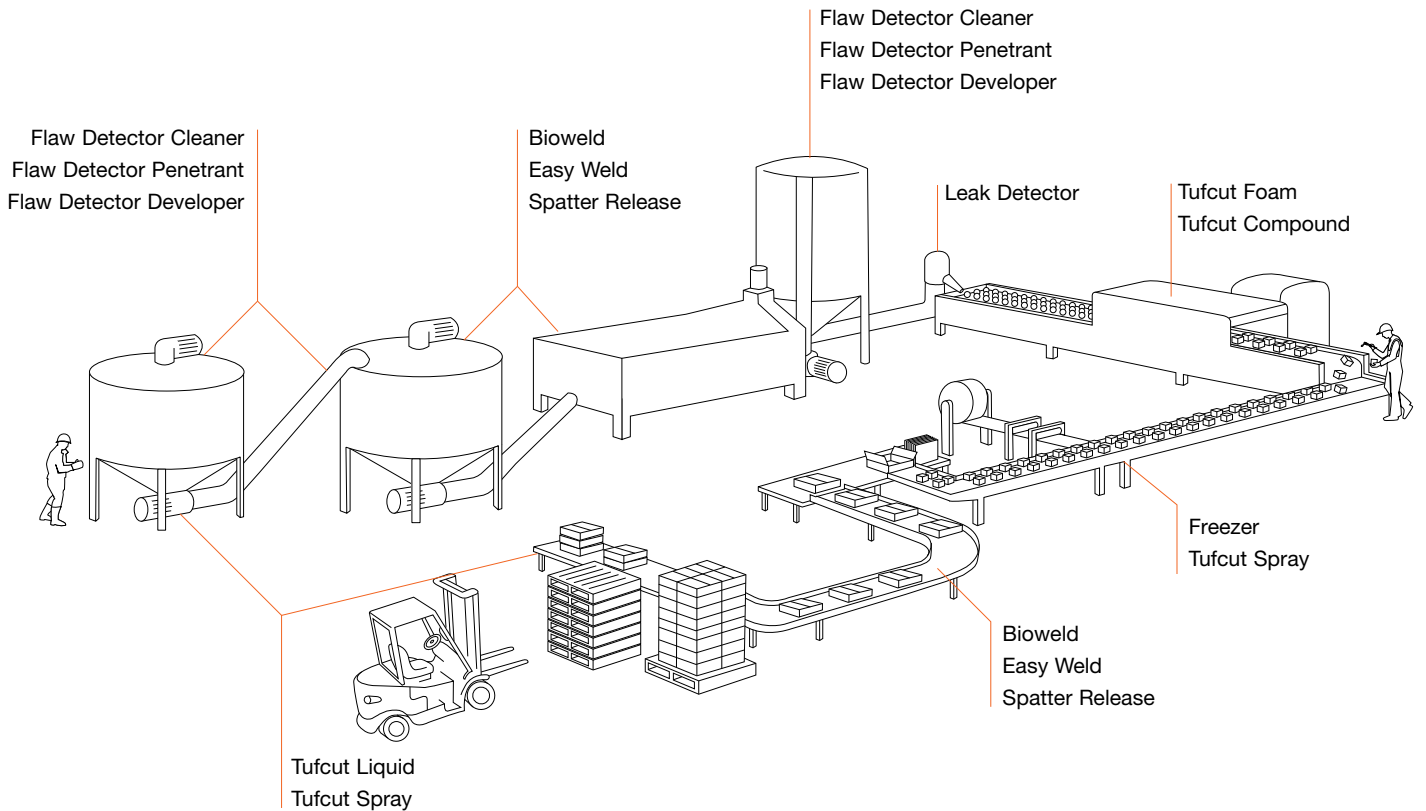





## BIOWELD

### WATER BASED WELD SPATTER RELEASE AGENT

A water based spatter release agent which gives exceptional results without the use of harmful solvents, silicones or mineral oils.

- Odourless, non-flammable and safe in use
- Fine spray pattern for excellent coverage
- Does not contain silicone or solvents
- Contains a highly effective flash-rust inhibitor
- Automotive approval: Ford Tox No.: 163241

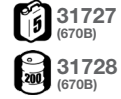
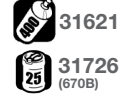

- HEAT DISSIPATION
- VISCOSITY
- ANTI-CORROSION
- POST-PROCESS RESIDUE



## EASY WELD

### BIODEGRADABLE ANTI-SPATTER

Easy Weld provides a quick, easy way to prevent the adherence of spatter to metal surfaces and eliminates the requirement for chiselling, grinding or extensive wire brushing after welding.

- Non-silicone heat resistant barrier
- Easy removal of spatter
- Economical in use due to thin film performance
- Based on biodegradable oil
- Keeps treated nozzles and equipment clear from spatter build-up



- HEAT DISSIPATION
- VISCOSITY
- ANTI-CORROSION
- POST-PROCESS RESIDUE



## LEAK DETECTOR

### WATER BASED GAS LEAK DETECTOR

Highly visible and easy to use gas leak detector for pipe and joints. Ideal for HVAC installations.

- Water-based formulation with no oils, silicone, solvents and no 'run-off' hazards
- Non-flammable and odourless
- Oxygen system safe
- Meets BS EN 14291:2004, and can be used for VOSA MOT testing



- MATERIALS COMPATIBILITY
- EASE OF USE
- FLAMMABILITY
- POST-PROCESS RESIDUE



## FLAW DETECTORS: CLEANER / PENETRANT / DEVELOPER

### DYE PENETRANT SYSTEM FOR NON-DESTRUCTIVE TESTING

Use as a highly accurate check for weld quality. Ideal for use on military vehicle repair, boiler maintenance, and storage tank fabrication.

- Fast acting visual results from NDT red dye system
- Can be applied directly to the component being tested without the need for dismantling
- Meets ASME Sec. V, RCC-M Tome 111 Chap, MoD

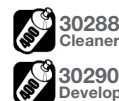

- MATERIALS COMPATIBILITY
- EASE OF USE
- FLAMMABILITY
- POST-PROCESS RESIDUE



# ANTI-CORROSION & PAINTS

Superior coatings for metal that prevent corrosion and allow aesthetic repair of damaged surfaces

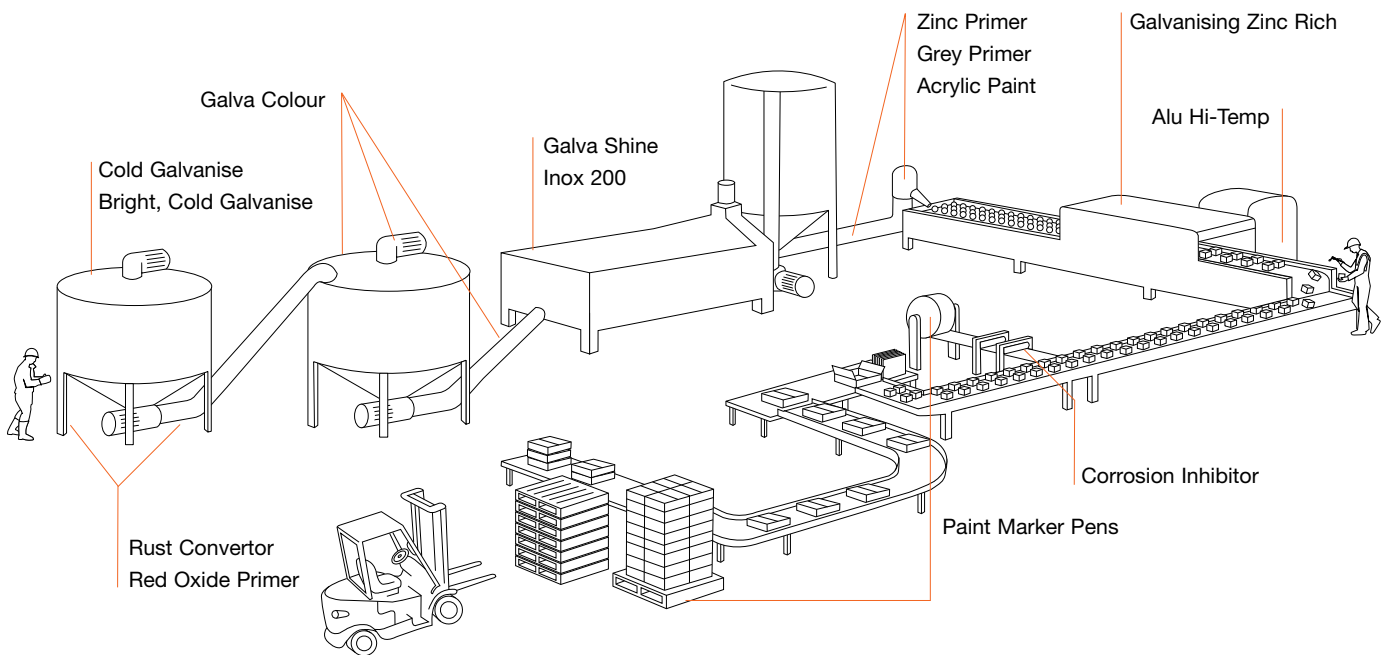

# Anti-Corrosion / Paints Selection Chart

Product Type	Application Requirement	Type of Duty	Recommended Product	Page		
<b>Anti-Corrosion</b>	Maximum Protection	Cathodic →	<b>COLD GALVANISE</b>	48		
		Passivating →	<b>RUST CONVERTER</b>	50		
		Weathers Naturally →	<b>BRIGHT, COLD GALVANISE</b>	24		
		Stainless Steel →	<b>INOX 200</b>	48		
<b>Paint</b>		Direct To Rust →	<b>GALVA COLOUR</b>	51		
		Aesthetic Repair →	<b>ACRYLIC PAINT</b>	51		
		Long-Lasting Shine/Alu Alloy →	<b>GALVA SHINE</b>	48		
		High Temperature →	<b>ALU-HT</b>	49		
		Primer →	Zinc →	<b>ZINC PRIMER</b>	50	
			Paint →	→	<b>GREY PRIMER</b>	51
				→	<b>RED OXIDE PRIMER</b>	51
		Very Rapid Drying →	Hammered →	<b>GALVANISING ZINC RICH</b>	48	
<b>Indoors/Covered</b>		Waxy Coating (Long-Term) →	<b>CORROSION INHIBITOR</b>	49		
		Oil Film (Short-Term) →	<b>40+</b>	30		
		Oil Film (Medium-Term) →	<b>PX24</b>	30		
		Battery Terminals →	<b>BATTERY TERMINAL PROTECTOR</b>	49		
		Food Grade →	→	<b>CLEAR MOULD PROTECTIVE</b>	64	
			Visible →	<b>BLUE MOULD PROTECTIVE FG</b>	63	
			Oily →	<b>MOISTURE REMOVER FG</b>	30	



## COLD GALVANISE

### ZINC RICH PROTECTIVE COATING

Provides cathodic protection to ferrous metals. Ideal for pipes, housings, structural metal, and as a primer. Particularly suited for protecting drilled or abraded surfaces.

- Sacrificial coating protects ferrous metal from corrosion
- For use on bare, clean, non-rusted steel and seams
- Suitable for use as a renovation media: BS EN ISO 1461:1999
- >99% pure zinc at 88% concentration in the cured film for the optimal balance between protection and adhesion



30291

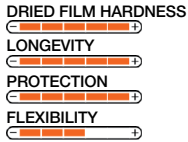

## BRIGHT, COLD GALVANISE

### REPAIR FOR HOT-DIP GALVANISED STEEL

Bright, Cold Galvanise goes on bright then weathers naturally for 'invisible' repairs.

- A barrier coating that protects ferrous metals from corrosion
- For use on bare, clean, non-rusted steel and seams
- Long-lasting corrosion protection
- Suitable as a top-coat for Cold Galvanise



30292

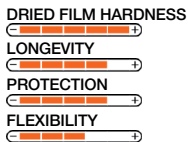

## GALVANISING ZINC RICH

### HIGH TEMPERATURE, RAPID DRYING PAINT

Use on metals subjected to intermittent high temperatures such as foundry lifting shackles, gantry arms and cranes.

- Touch dry in 15 minutes, complete cure in 24-hours
- Leaves a hammered semi-gloss finish
- The cured film can be welded through (except argon)
- Temperature range: -50°C to +550°C
- Use Amberklene FE10 fast drying solvent degreaser as the ideal surface preparation for best results



30300

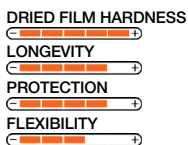

## GALVA SHINE

### AESTHETIC PROTECTIVE COATING

Offers an exact colour match to architectural hybrid zinc alloy galvanised structures.

- Resists weathering, retains a super bright finish
- Adheres strongly to metal offering a long-term barrier protective coating
- Superior spray pattern ensures a blemish free, smooth finish
- Use Amberklene FE10 fast drying solvent degreaser as the ideal surface preparation for best results



30293

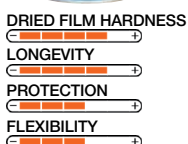





## CORROSION INHIBITOR

### WAXY ANTI-CORROSION TREATMENT

Use on ferrous metals as a long-term protective coating for stored equipment, or as a transportation film for trans-global component shipping.

- Film will not harden or crack
- Forms a 'self-repairing' waxy film
- Meets MIL-PREF-16173E
- Can be used as an anti-seize/anti-rust treatment for fasteners
- Will not stain or mark components

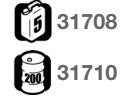
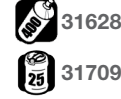
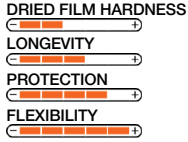

## BATTERY TERMINAL PROTECTOR

### ANTI-CORROSION TERMINAL TREATMENT

Protects battery terminals on fork lift trucks and generators from wear and corrosion and seals out moisture.

- Protective grease prevents wear to terminals through clip movement
- Highly visible dye gives an early indication of acid leakage by changing from pale yellow to red
- Viscous consistency prevents over application
- Excellent materials compatibility
- Operational temperature range: -10°C to +50°C

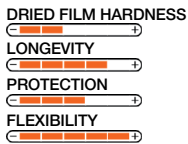

## ALU HI-TEMP

### HIGH TEMPERATURE CORROSION PROTECTION

Use on furnace doors, boiler casings, drying ovens, foundry manipulators and equipment subjected to continuous high temperatures.

- Protects to 600°C
- Lead and Chromate free
- Cures to a highly durable coating
- Effective barrier against corrosion

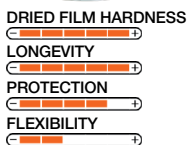

## INOX 200

### PROTECTIVE COATING FOR STAINLESS STEEL

Use on glass-pearl-blasted stainless steel as a touch-up paint.

- Touch dry in 10 minutes, complete cure 30 minutes
- Heat resistant up to 300°C
- Flexible yet hard dry film
- Contains chromium: the active corrosion inhibitor in stainless steel

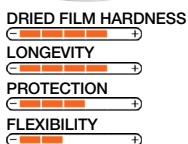



## ZINC PRIMER

### MULTI-PURPOSE METAL PRIMER

Zinc phosphate primer promotes adhesion of top-coat paint to 'difficult' substrates.

- Touch dry in 30 minutes
- Dry to over-coat in 1 hour (recommended 24-hour cure prior to over-painting)
- Best results achieved when the surface has been cleaned with Amberklene FE10 prior to application

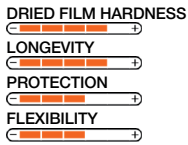

## RUST CONVERTER

### RESTORES CORRODED METAL

Passivates and binds rust to form a sound, paintable, protected surface.

- Ready to use - no dilution required
- Apply with a normal paint brush
- Non-corrosive
- Forms a durable, flexible coating
- Reduces the requirement for grinding corroded steel back to bare metal, saving time and money

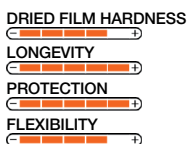

BEFORE

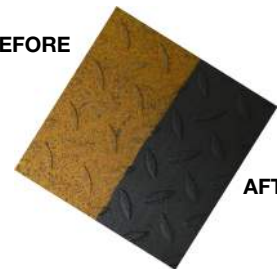

AFTER



## MARKER PENS

### ACRYLIC PAINT MARKER PENS

Can be used for metal working/fabrication, electrical installations, civil engineering, steel stock identification, batch number marking and more.

- Tenacious resin binds paint to the surface effectively eliminating the problems associated with accidental rub off and abrasion
- Can write through water/moisture and will not wash off with water/rain



COLOUR	CODE	COLOUR	CODE
WHITE	20394	ORANGE	20383
GREEN	20379	BLACK	20364
YELLOW	20399	BROWN	32061
BLUE	20368	VIOLET	32062
RED	20387		

Colour squares are representative only and may not match actual paint colour



## AQUA MARKER PENS

### ACRYLIC PAINT MARKER PENS

Innovative water-based paint marking pens for writing/markings on almost any surface. Ideal for quality control, batch identification and stock control.

- Tenacious resin strongly binds paint to surface
- Excellent opacity & clear marks
- No xylene, toluene or acetone - safer in use

COLOUR	CODE
WHITE	32493
BLACK	32494
YELLOW	32497
BLUE	32496
RED	32495

Colour squares are representative only and may not match actual paint colour



# ACRYLIC PAINT

## COLOUR MATCHED PROTECTIVE COATINGS

Vibrant acrylic paint for the repair and touch-up of painted surfaces.

- RAL matched for accurate colour matches
- Fast drying: touch dry in <5 minutes
- Once cured (24-hours) the paints have a high UV resistance
- Excellent flexibility and hardness
- Excellent adhesion to all surface types

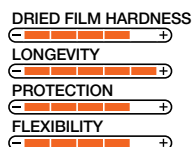

COLOUR	RAL	CODE	COLOUR	RAL	CODE
MATT BLACK	9011	20180	BRIGHT RED	3002	20184
MATT WHITE	9010	20181	BLUE	5015	20185
GLOSS BLACK	9005	20182	BATTLESHIP GREY	7032	20186
GLOSS WHITE	9016	20183	GREEN	6002	20187
SATIN BLACK	9005	32060	BRIGHT YELLOW	1018	20188
RITTAL GREY	7035	20195	CHROME SILVER		20190
FORD BLUE	5010	20555	FLUORESCENT GREEN		20191
JCB YELLOW	1007	20556	FLUORESCENT YELLOW		20192
MASSEY FERGUSSON RED	3000	20557	FLUORESCENT RED		20193
JOHN DEERE GREEN	6001	20558	GREY PRIMER		20189
BELLE ORANGE	2004	20559	RED OXIDE PRIMER		32379

Colour squares are representative only and may not match actual paint colour



# GALVA COLOUR

## 2-IN-1 ANTI-CORROSION PRIMER AND COLOUR TOP COAT

Use on surfaces which have surface rust, old paint or otherwise 'imperfect' finish.

- Reduces time spent priming and painting the top-coat: do it in one application
- RAL colours for accurate colour matches
- Free from lead, chromate and toluene
- Ideal for external pipe-line identification, railings, security fences, and storage tanks.
- Excellent coverage: up to 3m<sup>2</sup> from one 500ml can

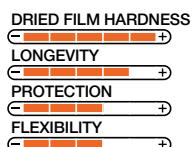

COLOUR	RAL	CODE
YELLOW	1004	20673
RED	3000	20674
VIOLET	4001	20675
BLUE	5012	20676
GREEN	6010	20677
BROWN	8001	20678
BLACK	9005	20679
SILVER	9006	20680
WHITE	9010	20681

Colour squares are representative only and may not match actual paint colour





# ADHESIVES / SEALANTS

Essential bonding, adhesion, and gasketing products for industrial maintenance



## ADHESIVE MP 100

**MULTI-PURPOSE ADHESIVE**  
Ideal for bonding almost anything to most hard surfaces including wood and metal.

- Tack time approximately 30 seconds
- Permanent bonds
- Our best selling adhesive
- Big value 500ml fill size

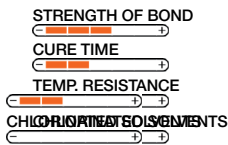

31624



## ADHESIVE NC 500

**NON-CHLORINATED ADHESIVE**  
Use where a non-chlorinated multi-purpose adhesive is required.

- Tack time approximately 2 to 4 minutes
- Free from chlorinated solvents for improved user safety
- Variable spray pattern
- Big value 500ml fill size

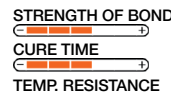

31623



## ADHESIVE HS 300

**HIGH STRENGTH ADHESIVE**  
Use where a high strength adhesive is required e.g. warning and information signs.

- Tack time less than 10 minutes
- Free from chlorinated solvents for improved user safety
- Shear strength: >375 N per inch (25 mm<sup>2</sup>)
- Big value 500ml fill size

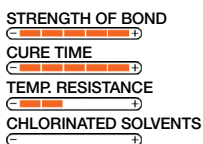

31625



## ADHESIVE QS 900

**QUICK STICK ADHESIVE**  
Especially useful where instant grab is required to avoid slippage.

- Tack time approximately 30 seconds
- Free from chlorinated solvents for improved user safety
- Instant grab and hold
- Big value 500ml fill size

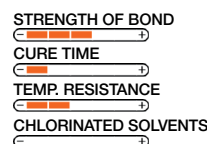

31626



## 5024A SILICONE ADHESIVE SEALANT

### HIGH MODULUS, ACETOXY CURE SILICONE SEALANT

A ready to use one part silicone sealant suitable for use as a general purpose sealing and bonding agent. Ideal for making formed-in-place gaskets.

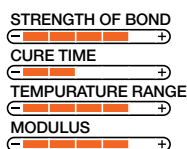

- Offers excellent adhesion to a wide variety of non-porus substrates such as glass, glazed ceramics, aluminium and metal
- Conforms to ISO 11600
- High Modulus & Non-Slump
- Temperature resistance: -60°C to + 204°C
- 310ml cartridge

	WHITE	30730
	GREY	30735
	CLEAR	31753
	BLACK	30732
	SILVER GREY	31753



## 5005A SILICONE ADHESIVE SEALANT

### HIGH MODULUS, ACETOXY CURE SEALANT

A ready to use one-part RTV silicone sealant suitable for use as a general purpose sealing and bonding agent. Ideal for making formed-in-place gaskets.

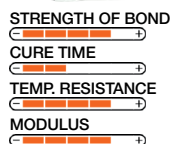

- Excellent adhesion to a wide variety of non-porous substrates
- Maximum temperature resistance: 204°C
- Portable 75ml syringe with plunger
- Conforms to ISO 11600
- High modulus & non-slump



31644



## HIGH TEMPERATURE GASKET SEALANT

### GASKET SEALANT FOR ARDUOUS CONDITIONS

A high quality, ready to use, one-part RTV gasketing sealant for the replacement of high temperature gaskets and seals.

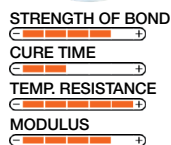

- Touch dry in 30 minutes, full cure in 24 hours
- High modulus & non-slump
- Operational temperature range: -60°C to +260°C (300°C intermittent)
- 310ml cartridge



31455



## 5-MINUTE EPOXY

### FAST REPAIR PURE EPOXY RESIN

For the rapid creation of strong, permanent bonds. It can be used as a hole filler and is able to be drilled once cured.

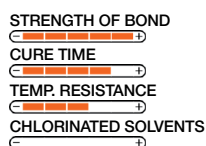

- Simple, ready to use 2-part epoxy adhesive with twin syringe dispensing system for correct adhesive/hardener mixing
- Cure time: 3 to 5 minutes (full cure: 1 hour)
- Temperature range: -20°C to +120°C
- Handy, portable 24ml syringe

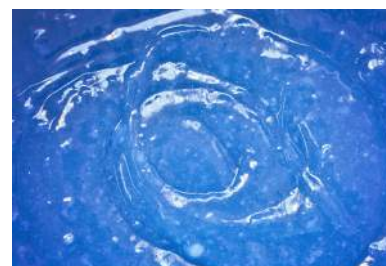

31895





# POLYMER PROCESSING

Release agents, protectives, cleaners and compounds for all types of plastics, rubbers, and composites moulding operations





# Polymer Processing Selection Chart

Product Type	Application Requirement	Characteristics	Recommended Product	Page
<b>Silicone</b>	Nylon, PP, PE	Heavy Duty	→ <b>FORMULA 1</b>	56
	Synthetic Fibres: Nylon - Non-Flammable	High Temp / Heavy Duty	→ <b>FORMULA 1 HT</b>	56
	PU	High Gloss	→ <b>PUR 400</b>	57
	Thermoplastics & Rubber	Medium Duty	→ <b>FORMULA 6</b>	56
	Non-transfer	Semi-Permanent Dry Film	→ <b>DP 200</b>	60
	ABS, PE, PP, PVC, PA, PU	Paintable/Post-Process OK	→ <b>FORMULA 20</b>	57
	Plastics & Rubber	General Purpose	→ <b>HD-SIL RELEASE</b>	57
	Rubber & Natural Polymers	Medium Duty	→ <b>FORMULA 2</b>	56
	Plastics & Rubber	Light Duty	→ <b>FORMULA 8</b>	56
<b>Non - Silicone</b>	Thermoplastics	Heavy Duty	→ <b>FORMULA 7</b>	58
	Thermoset, PU, Epoxy, PE	Dry Film	→ <b>FORMULA 10</b>	58
	PVC, PU & Flexible Polymers	Wet Film	→ <b>FORMULA 4</b>	58
	Electronic 'Grade' Polymers	Minimal Transfer	→ <b>FORMULA 11</b>	59
	LDPE, HDPE, PP, PVC, PS, POM, PA	Multiple Releases	→ <b>FORMULA 14</b>	59
	Thermoplastics	Heavy Duty	→ <b>NO-SIL RELEASE</b>	60
	Fine Details Thermoplastics	Medium Duty, Dry Film	→ <b>FORMULA 5</b>	58
	Synthetic Rubbers, PP, PE	Semi-Permanent	→ <b>FORMULA 12</b>	59
	GRP, Epoxy, PE, Rotational	Semi Permanent	→ <b>RELEASE 100</b>	60
	<b>Specialist</b>	General Purpose	Water Based — Silicone	→ <b>MPR100</b>
Concentrated		Water Based — Silicone	→ <b>MPR200</b>	61
Rotational Moulding		Water Based — Semi-Permanent	→ <b>ROM300</b>	62
GRP, High Gloss		Wax	→ <b>COM300</b>	61
Composites (inc: Boron, Amide, & Carbon)		Semi-Permanent	→ <b>COM400</b>	61
Semi-Rigid & Integrated Skin PU		Solvent Based — Wax & Silicone	→ <b>PUR101</b>	61
Rigid Insulation & Semi-Rigid PU		Solvent Based — Allows Post-Process Painting	→ <b>PUR300</b>	62
High Gloss Elastomeric PU		Solvent Based — Wax & Silicone	→ <b>PUR400</b>	57
Rubber Release		Water Based — Semi-Permanent	→ <b>RBR100</b>	62
Concentrated Rubber & Silicone Rubber Release		Water Based — High Temperature	→ <b>RBR310</b>	62
<b>Food &amp; Beverage Packaging</b>		Mould / Packaging Release (Food Contact)	Silicone	→ <b>SILICONE RELEASE FG</b>
	Non-Silicone		→ <b>NON-SILICONE RELEASE FG</b>	59
	Mould Tool Protection	Visible — Blue	→ <b>BLUE MOULD PROTECTIVE FG</b>	63
		Clear	→ <b>CLEAR MOULD PROTECTIVE</b>	64
	Mould / Tool & General Cleaner	Solvent	→ <b>SOLVENT CLEANER FG</b>	65



## FORMULA 6

### MEDIUM DUTY SILICONE RELEASE AGENT

A general purpose release agent for all thermoplastics and many types of rubber. It is highly versatile as a release agent, ensuring accurate mould detail and improving surface finish without building up in the mould.

- Improves surface finish, minimises imperfections, and enhances even well polished tool release properties
- Operational to +200°C
- Can also be used as an anti-stick agent in the textile, foam converting, printing, and shoe industries



- RELEASE LEVEL
- TEMP. RESISTANCE
- NUMBER OF RELEASES
- APPLIED FILM TRANSFER



## FORMULA 1 & FORMULA 1 HT

### HEAVY DUTY SILICONE RELEASE AGENTS

Heavy duty, high silicone concentration, mould release agent available as either a 'regular' or 'high temperature' version.

- Operational temperature up to +200°C for regular version
- Automotive approved: Ford Tox No.: 168735
- Formula 1 HT is a highly effective spinneret lubricant for use in the manufacture of synthetic fibres
- "HT" Version: +200°C continuous, +300°C intermittent



- RELEASE LEVEL
- TEMP. RESISTANCE
- NUMBER OF RELEASES
- APPLIED FILM TRANSFER



## FORMULA 2

### SILICONE RELEASE AGENT FOR RUBBER

A medium duty, silicone based release agent formulated to release natural rubber and polymers with lower melt temperatures.

- A wet silicone film for the release of moulded rubber parts
- Provides an improved surface finish and will not build up in the mould
- Operational to +200°C
- Particularly effective for use in the tyre industry
- A versatile release agent



- RELEASE LEVEL
- TEMP. RESISTANCE
- NUMBER OF RELEASES
- APPLIED FILM TRANSFER



## FORMULA 8

### LIGHT DUTY, SILICONE MOULD RELEASE AGENT

Light duty, silicone mould release agent that provides a highly effective release for plastic and rubber moulding.

- Especially suitable for fine detail and precision mouldings
- Use for injection moulding, compression moulding, and vacuum forming processes
- Suitable for wax pattern release in investment casting



- RELEASE LEVEL
- TEMP. RESISTANCE
- NUMBER OF RELEASES
- APPLIED FILM TRANSFER





## FORMULA 20

### PAINTABLE SILICONE RELEASE AGENT

Specialist mould release agent based on a unique active material that allows post-moulding operations e.g. coating, painting, plating, and adhesion.

- No oily film - reduces the requirement to clean
- Effective on a wide variety of materials including: ABS, Polyethylene, Polypropylene, PVC, Polyamides, and Polyurethanes
- Removes the need to wax wash in investment casting

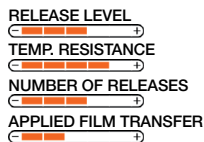

30227



## SILICONE RELEASE FG

### FOOD GRADE SILICONE RELEASE AGENT

A high purity silicone release agent for packaging and moulding operations within the food/beverage sector.

- NSF registered M1 and H1
- Suitable for use as a mould release agent and packaging machine anti-stick oil where the finished article will have direct to food contact
- Maximum operational temperature : +200°C
- Totally clean, clear, and non-staining 'wet' film

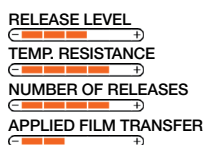

32454



## HD SIL RELEASE

### GENERAL PURPOSE SILICONE MOULD RELEASE

A wet film, general purpose silicone release agent with excellent anti-stick and slip properties. Particularly suited to injection moulding.

- A clean, colourless, odourless release agent
- Leaves an oily, heavy duty silicone film for multiple releases
- Operational to +200°C
- Excellent materials compatibility

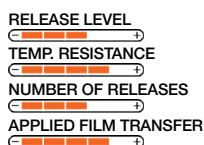

32353



## PUR 400

### SILICONE RELEASE AGENT FOR PU

A silicone release agent that has been specifically formulated to provide a fine release film for use with integral skin and elastomeric polyurethanes.

- High quality, high gloss, even finish
- Fine spray pattern for excellent coverage
- Low odour
- No build up on mould surface - suitable for use on low temperature mouldings
- Operational to +200°C

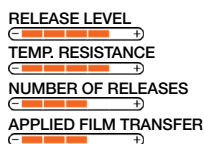

31537

31751

30317





## FORMULA 5

### MEDIUM DUTY, NON-SILICONE RELEASE AGENT

A medium duty, dry film, non-silicone mould release agent that provides an excellent release for all types of thermoplastics, some thermosetting plastics, silicone rubber, and most other rubber types.

- Will not interfere with post moulding treatments such as painting, printing, bonding, or plating
- Does not build up in the mould
- Operational to +150°C
- Automotive approval: Ford Tox No: 174011



31540



31679



RELEASE LEVEL  
 TEMP. RESISTANCE  
 NUMBER OF RELEASES  
 APPLIED FILM TRANSFER



## FORMULA 4

### NON-SILICONE RELEASE AGENT FOR PVC

Excellent release for PVC, Polyurethane elastomers, and other flexible polymers. Ideal for the release of moulded shoe soles.

- A wet film mould release that imparts a gloss finish to moulded parts
- Will not interfere with post moulding operations
- Does not build up in the mould
- Operational temperature to +200°C
- Passes crib source 5, Furniture & Furnishings (Fire Safety) Regulations 1988



31548



RELEASE LEVEL  
 TEMP. RESISTANCE  
 NUMBER OF RELEASES  
 APPLIED FILM TRANSFER



## FORMULA 7

### HEAVY DUTY, NON-SILICONE RELEASE AGENT

A wet film, non-silicone release agent that provides excellent release on a wide range of thermoplastics and rubbers.

- Will not interfere with post-moulding operations such as painting, bonding, plating, or printing
- Does not build up in the mould
- Operational temperature up to +170°C



31539



31681



30006



RELEASE LEVEL  
 TEMP. RESISTANCE  
 NUMBER OF RELEASES  
 APPLIED FILM TRANSFER



## FORMULA 10

### DRY FILM, NON-SILICONE RELEASE AGENT

Highly effective release agent for thermosetting plastics. Provides excellent release properties on polyurethanes, epoxy resins, and polyesters.

- Will not interfere with post-moulding operations such as painting, bonding, plating, or printing
- Release agent does not build up in the mould
- Operational temperature to +180°C
- Utilises fluorinated resins as the active release component



31541



RELEASE LEVEL  
 TEMP. RESISTANCE  
 NUMBER OF RELEASES  
 APPLIED FILM TRANSFER



## FORMULA 11

### ELECTRONIC NON-SILICONE RELEASE AGENT

A minimal transfer 'electronic' grade non-silicone release agent with an ultra-thin, dry film. Ideal for use with polymers such as Polycarbonate, ABS and HIPS (high impact styrene).

- Will not interfere with post moulding treatments such as painting, printing, bonding, or plating.
- Operational temperature to +150°C

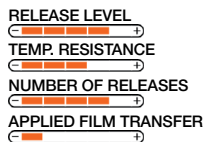

31542



## NON-SILICONE RELEASE FG

### FOOD GRADE NON-SILICONE RELEASE AGENT

A non-silicone release agent with NSF registration for use in the food/beverage industry as a packaging release.

- NSF M1 & H1 registered
- Use on food packaging which is intended for direct food contact such as plastic containers and sandwich boxes
- Will not interfere with post moulding operations such as bonding and labelling
- Operational temperature to +170°C

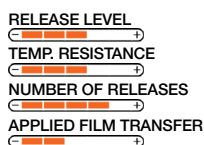

32446



## FORMULA 12

### SEMI-PERMANENT NON-SILICONE RELEASE

Non-silicone release agent formulated to release a wide variety of synthetic rubbers and many thermoplastics such as polypropylene and polyethylene.

- Forms a thin, inert and thermally stable coating from which multiple releases can be expected
- Fast cure time. Moulding can commence 5-10 minutes after application
- Operational temperature to +250°C

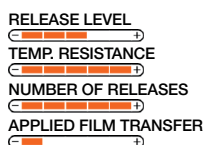

31544



## FORMULA 14

### NON-SILICONE RELEASE AGENT

Non-silicone release agent specifically developed for the release of thermoplastics: LDPE, HDPE, PP, PVC, PS, POM, PA.

- Excellent release properties in a durable film
- Operational temperature up to +200°C
- Multiple releases per application can be achieved giving improved economy in use

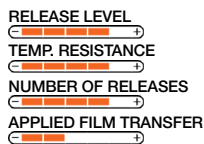

30226







## NO-SIL RELEASE

**HEAVY DUTY NON-SILICONE RELEASE AGENT**  
Provides a wet, heavy duty film for the release of plastic and rubber parts.

- Allows decorative treatment of the moulded part (e.g. painting)
- For use in injection moulding, vacuum forming and many other forming processes
- Operational temperature to +170°C



31971



RELEASE LEVEL	
TEMP. RESISTANCE	
NUMBER OF RELEASES	
APPLIED FILM TRANSFER	



## RELEASE 100

**SOLVENT BASED SEMI-PERMANENT RELEASE**  
Specifically formulated to give multiple releases of a wide range of fibre reinforced polymers (including epoxy).

- Low odour and easy to apply
- Fast room temperature cure for maximum productivity
- High gloss & high slip
- Non-transferring film will not interfere with post moulding operations such as bonding, plating, coating, or labelling
- Highly versatile for use in many moulding operations



31746



RELEASE LEVEL	
TEMP. RESISTANCE	
NUMBER OF RELEASES	
APPLIED FILM TRANSFER	



## DP 200

**SEMI-PERMANENT SILICONE RELEASE AGENT**  
A silicone resin based, air-curing, highly durable, dry film, semi-permanent release coating.

- Formulated for moulding processes where the use of 'free silicone' can cause stress cracking.
- Suitable for use in rotational moulding operations
- Operational temperature to +200°C
- Rolls Royce Approved: 116061



31538



RELEASE LEVEL	
TEMP. RESISTANCE	
NUMBER OF RELEASES	
APPLIED FILM TRANSFER	



## MPR 100

**READY TO USE WATER BASED SILICONE EMULSION RELEASE AGENT**  
Releases many types of plastic and rubber, especially PVC and rubber profile extrusions.

- Effective release of concrete/stone castings
- Operational temperature up to +150°C
- Economical in use and environmentally 'friendly'



31734



RELEASE LEVEL	
TEMP. RESISTANCE	
NUMBER OF RELEASES	
APPLIED FILM TRANSFER	

## MPR 200

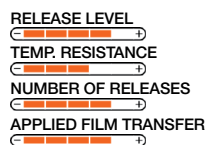

### READY TO USE WATER BASED SILICONE EMULSION RELEASE AGENT

Releases many types of plastic and rubber, especially PVC and rubber profile extrusions

- Especially suitable for use with PVC and rubber profile extrusions
- Can be used as-is (neat) or diluted for extra economy
- Double the active level of MP100
- Greater economy in use



## COM 300

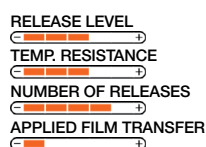

### GENERAL PURPOSE WAX RELEASE AGENT

A general purpose liquid wax release agent effective on the following moulds: gel coated, non-gel coated, MDF, plaster, timber and aluminium.

- Simply and easy to apply liquid that can be buffed to a high gloss finish
- Multiple release of moulded components before re-coating is required



## COM 400

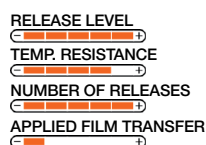

### SEMI-PERMANENT RELEASE AGENT FOR PERFORMANCE COMPOSITES

Releases epoxies, polyester, thermoplastics, thermosetting resins, boron, amide, and graphite/carbon fibre composites.

- Exhibits a fast dry time with minimal mould build up
- Practically zero applied film transfer with high thermal stability
- Ideal for use with 'difficult' moulding operations



## PUR 101

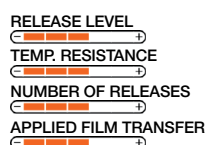

### RELEASE AGENT FOR SEMI-RIGID AND INTEGRAL SKIN POLYURETHANES

PUR 101 is a specialised mould release agent based upon a mixture of waxes and non-curing silicone resins in a blend of fast evaporating solvents.

- Formulated for moulding of polyurethanes, the product has proved particularly effective in automotive applications
- Minimal build up and transfer





## PUR 300

### MOULD RELEASE AGENT FOR RIGID AND SEMI-RIGID POLYURETHANES

Specifically formulated to facilitate the release of high density rigid polyurethanes and refrigeration/insulation foams.

- Does not interfere with post moulding operations, allowing bonding, plating, painting, and labelling
- Reduced post moulding costs (no degreasing required)

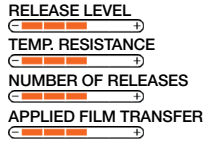

31749



31750



## ROM 300

### WATER-BASED, SEMI-PERMANENT ROTATIONAL MOULDING RELEASE AGENT

Specially formulated water based release agent for use in rotational moulding operations.

- Fast curing with a lower mould residue build-up
- Non-flammable
- Reduced environmental impact, safer in use

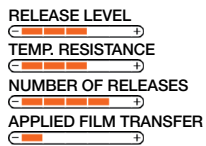

31739



## RBR 100

### SEMI-PERMANENT RUBBER RELEASE AGENT

A water based, semi-permanent release agent for use in a wide variety of rubber moulding operations.

- Use for the release of all natural and synthetic grades of rubber
- Fast curing with lower mould build-up
- Non-flammable and environmentally 'safe'

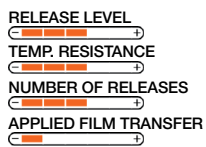

31740



## RBR 310

### RELEASE AGENT FOR NATURAL, SYNTHETIC, AND SILICONE RUBBERS

Concentrated release agent for rubber moulding release.

- Water based with zero mould build up and minimal transfer, allowing multiple releases before re-application is required
- High 'active level' acts as a primer for new and porous mould surfaces
- Operational temperature to +250°C

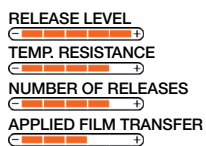

31743



31744







## EJECTOR PIN LUBRICANT

### MOULD TOOL LUBRICANT

A heavy duty, viscous lubricant for ejector pins and other close tolerance mould tool parts.

- Viscous film prevents creep onto mould tool face
- Lubricating film is clear and non-staining
- Operational temperature to +120°C

MATERIALS COMPATIBILITY

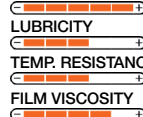

## MOULD PROTECTIVE

### CORROSION INHIBITOR FOR MOULD TOOLS

Non-silicone corrosion inhibitor for injection moulding tools and dies.

- Repels and displaces moisture leaving a durable, non-greasy protective film
- Applied film will not harden or crack
- Allows handling and resists acid finger marks
- Light yellow film ensures total coverage can be seen
- Cured film will not stain moulds

CURED FILM DRYNESS

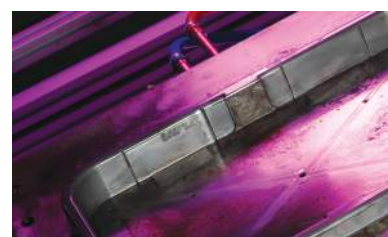

## GREEN MOULD PROTECTIVE

### HIGHLY VISIBLE CORROSION INHIBITOR

Tenacious and long-lasting anti-corrosion treatment for mould tools. The highly visible green spray provides easy visual inspection to ensure complete coverage.

- Non-silicone corrosion inhibitor for injection moulding tools
- Repels and displaces moisture leaving behind a durable protective film for excellent long-term tool storage
- Waxy film allows handling & will resist acid finger marks
- Easily moulded off once production recommences
- Ideal for the long-term storage of mould tools

CURED FILM DRYNESS



## BLUE MOULD PROTECTIVE FG

### HIGHLY VISIBLE CORROSION INHIBITOR FOR FOOD PACKAGING

A waxy, long lasting coating for mould tools and dies which is NSF registered for use in the food/beverage sector.

- Non-silicone corrosion inhibitor for injection moulding tools
- NSF H2 registered (N°149685)
- Ideal for long-term storage of mould tools, dies, and jigs
- Highly visible blue dye provides an easy visual method for ensuring complete coverage
- Easily moulded off once production recommences

CURED FILM DRYNESS





## TOOL GUARD

### LIGHT GREEN MOULD TOOL PROTECTIVE

A light green, viscous, protective coating for use on mould tools. It removes moisture and provides good, long-term protection to surfaces.

- Easy identification of treated areas for total coverage
- Will not penetrate or creep into the mould tool
- Resists high humidity and acid finger marking
- Easy to apply with good wetting properties
- Excellent corrosion protection

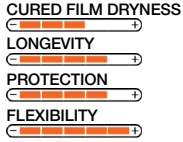

31972



## CLEAR MOULD PROTECTIVE

### TRANSPARENT CORROSION INHIBITOR

Use on moulds as a long-term protective during storage. Now with NSF registration for use on food/beverage packing mould tools.

- Displaces moisture leaving a durable, non-greasy protective film
- NSF H2 registered (N°49688)
- Will not stain or mark the mould; suitable for use with white and transparent polymers
- Easily "moulded off" when production recommences
- Waxy film allows handling and resists acid finger marks

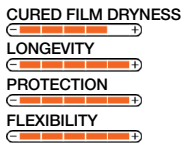

31547



## POLYMER REMOVER

### HEAVY DUTY MOULD CLEANER

Highly effective and powerful solvent blend developed for use on polymer residues and soiled tooling/equipment.

- Controlled rate of evaporation for maximum efficiency
- Removes: plastics, rubbers, and resin deposits including: ABS, Acetyls, Acrylates, PVC, Epoxy Resins (uncured), Polyamides, Polystyrenes, Silicone Resins, and Rubbers
- It will also remove other materials such as cellulose resins and alkyd resins

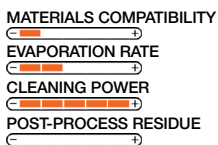

31551

31688



## POLYKLENE R

### INJECTION MOULDING AND EXTRUSION EQUIPMENT CLEANING COMPOUND

A screw and barrel cleaning compound that changes state when heated in the barrel, reaching into the dead spaces where burnt material will settle.

- Removes residues of previous production runs e.g. black specs caused by burnt on resin
- Reduce scrap rates by removing tainting residues, such as pigments during colour changes

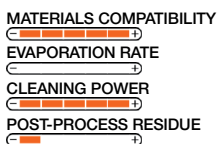

2.5kg 31683

25kg 31684





## MOULD CLEANER

### GENERAL CLEANER FOR MOULD TOOLS

A powerful solvent blend formulated to remove a wide range of common soiling from moulds, tools & dies.

- Quickly and easily removes oils, grease, old protective films & release agents
- Ideal for removing old release agents
- Evaporates to leave a clean, dry, residue free surface
- Special formulation allows use on hot production tooling without excessive solvent loss

MATERIALS COMPATIBILITY  
 EVAPORATION RATE  
 CLEANING POWER  
 POST-PROCESS RESIDUE



## SOLVENT CLEANER FG

### FOOD GRADE SOLVENT CLEANER FOR MOULD TOOLS

A general purpose solvent cleaner that is suitable for use in the food/beverage sector.

- Quickly removes oils, greases, waxy protective films, and release agent residue
- Evaporates to leave a clean, dry, residue free surface
- Excellent materials compatibility
- Low odour

MATERIALS COMPATIBILITY  
 EVAPORATION RATE  
 CLEANING POWER  
 POST-PROCESS RESIDUE



## POLYESTER MOULD CLEANER

### SOLVENT CLEANER FOR MOULDS

A blend of powerful solvents specifically developed to remove semi-permanent mould release coatings for GRP from a range of mould substrates.

- Safe for use on GRP and gel coated moulds
- Effective removal of semi-permanent, silicone, and wax release agents
- Compatible with all Ambersil composite release agents

MATERIALS COMPATIBILITY  
 EVAPORATION RATE  
 CLEANING POWER  
 POST-PROCESS RESIDUE

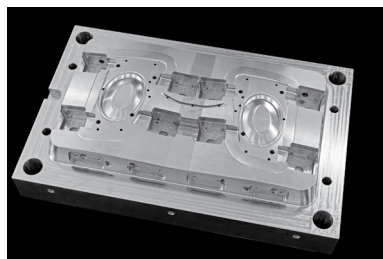

## MOULD SOLV

### SOLVENT CLEANER FOR MOULDS & TOOLS

A medium power, low odour solvent for the general cleaning and preparation of mould tools.

- Highly effective low odour degreasing agent
- Safe for use on plastics, metals, painted and glazed surfaces
- Removes anti-corrosion coatings and old release agents

MATERIALS COMPATIBILITY  
 EVAPORATION RATE  
 CLEANING POWER  
 POST-PROCESS RESIDUE





**ADD**

The Aerosol Dispensers Directive is a piece of European legislation, the primary purpose of which is to protect consumer and end-user safety in relation to the use of aerosol dispensers. Amongst other criteria, ADD requires that all filled aerosols are tested to ensure complete integrity (water bath testing to 50°C) and that all formulations are thoroughly tested to evaluate potential flammability – and labelled accordingly. With the addition of the compliance mark (the reversed epsilon 'ε') located on the aerosol can itself, consumers are able to confirm that the aerosol has been tested to rigorous EU standards.

**AEROSOL**

A self-contained sprayable product comprising of a mixture of active ingredients, carriers and propellant contained in a steel or aluminium container which discharges the formulation under pressure. Aerosols are hermetically sealed, ensuring risk of spillage is removed, storage simplified, and combustion risks minimised - all benefiting Health & Safety guidelines. Assists with precise and controlled application.

**BARRIER PROTECTION**

Barrier protection is one of two primary methods of protecting metals from corrosion. By coating the metal with a suitable product (e.g. Acrylic Paints; Bright, Cold Galvanise; Inox 200, etc), corrosion is unable to take place because electrolytes (such as rain water) are unable to come into contact with the metal and an electron flow cannot be established, thus preventing galvanic corrosion.

**BIODEGRADATION / BIODEGRADABLE**

The process by which organic substances are broken down into harmless constituents by the natural action of living micro-organisms.

**CATHODIC PROTECTION**

Cathodic protection is based on the ionic charge of the metal and the reversal or mitigation of the flow of electrons as found in galvanic corrosion. The protective coating applied should have a lower potential (volts) than the metal it is to protect so that the coating is corroded in preference to the base metal – with protection often extending beyond the physical edge of the coating. By offering itself for corrosion instead of the base metal, this type of coating is often termed 'sacrificial' and is, in essence, how galvanised steel is protected.

**CHLORINATED SOLVENTS**

Chlorinated solvents are organic solvents which contain chlorine atoms as part of their chemical make-up. These compounds are very effective solvents for oils and greases.

**DIELECTRIC STRENGTH**

The maximum electrical field strength that an insulating material can withstand intrinsically without decomposing, usually specified in volts per millimetre of thickness. Also known as the breakdown voltage.

**EDTA**

EDTA is the chemical compound ethylenediaminetetraacetic acid, also known as diaminoethanetetraacetic acid disodium salt. It is most commonly used as a constituent in water based cleaning chemicals to bind with a water soluble compound. This use has now become less prominent due to concerns over the biodegradability and EDTA has also found some specialist uses as a preservative in some processed foods and cosmetics.

**EMULSION**

A combination of water-soluble and water insoluble chemical groups held together by a surfactant. Emulsions are usually milky white.

**EVAPORATION RATE**

The rate at which a material will vaporise (evaporate) when compared to the known rate of vapourisation of a standard material. The designated standard material is usually n-butyl acetate, with a vaporisation rate designated as 1.0. The higher the number, the faster the evaporation rate.

**FDA**

The FDA (Food and Drugs Administration) ensures that all ingredients used in foods are safe, and that food is free of contaminants such as disease-causing organisms, chemicals, or other harmful substances. The FDA reviews the results of laboratory, animal and human clinical testing conducted by companies to determine if the product they wish to place on the market is safe and effective. The FDA does not develop or test products itself, nor issue approvals'.

**FLASH POINT**

The lowest temperature at which the vapours of a solvent will flash (ignite) under specific test conditions.

**GALLING**

The process by which metal components 'cold weld' and seize. When two metals are brought together under pressure, the action of forcing the surfaces together can cause the contacting faces to begin to combine at an atomic level, fusing the pieces together. Where stainless steel or aluminium alloys are used, the friction can scour off the thin, non-reactive protective oxide layer, exposing clean reactive material - allowing atomic fusing to occur. Galling can be prevented by the use of a lubricant, such as bearing grease, however, grease needs to be 'worked' before full lubrication is achieved, therefore a running-in paste should be used to prevent galling in this start-up period.

**GALVANIC CORROSION**

Is an electrochemical process which occurs when two metals with differing electrical potentials are in contact with each other in the presence of an electrolytic solution (such as rain water).

**GALVANISING**

Galvanising is the process by which clean, degreased ferrous metal (i.e. steel) has a layer of zinc applied to its surface using extreme heat to form an inseparable alloy at the point where the two layers are fused. Zinc will be corroded in preference to the ferrous substrate thereby preventing structural corrosion. This type of coating is referred to as a 'sacrificial coating'.

**GHS/CLP:**

The Classification, Labelling and Packaging (CLP) Regulation implements the UN Global Harmonised System (GHS) in all EU member states. Currently there are several differing pieces of legislation relating to the classification, labelling and packaging of dangerous substances worldwide. GHS will implement identical criteria for classifying chemicals according to the health, environmental and physical hazards; and also for how hazards are communicated via product labels and MSDS's. Manufacturers will need to plan the phase-in of complete label and packaging (print) re-design; the updating of all MSDS's and the communication of these changes through the channel. These changes will include the introduction of new hazard warning pictograms and harmonised warning and precautionary statements on labels, which will replace the existing risk and safety phrases.

**GWP:**

Abbreviation for "Global Warming Potential". GWP is an industry recognised, arbitrary measure of the effect of various chemicals on global warming. The benchmark reference is Carbon Dioxide (CO<sub>2</sub>) with a score of 1 for 1kg. A product that contributes twice as much to global warming would have a score of 2 for 1kg, indicating double the impact for the same amount. As the number gets higher, so the effect of 1Kg of the material can be seen to be proportionally more severe than CO<sub>2</sub>. The score allows users and specifiers to consider the environmental impact of the products they are using. Not all products on the market will have a GWP score.

**HAZARD SYMBOLS:****EXTREMELY FLAMMABLE (F+)**

Liquid chemicals having an extremely low flash point and low boiling point and gaseous chemicals which are flammable in contact with air at ambient temperature and pressure in the presence of an ignition source.

**HIGHLY FLAMMABLE (F)**

Liquid chemicals that have a very low flash point.

**HARMFUL (Xn)**

Chemicals that may cause damage to health when inhaled swallowed or absorbed via the skin.



## IRRITANT (Xi)

Chemicals that may cause inflammation to the skin or other mucous membranes through immediate, prolonged or repeated contact.



## DANGEROUS FOR THE ENVIRONMENT (N)

Chemicals that may present an immediate or delayed danger to one or more components of the environment.



## ISO 9001

Internationally recognised Quality Management system standard, indicating Ambersil's commitment to quality and continuous improvement. The standard has been developed to provide a framework around which a quality management system can effectively be implemented.

## ISO 14001

Internationally recognised environmental management standard. Specifies the requirements for an environmental management system; provides a framework for an organisation to control the environmental impacts of its activities, products and services, and to continually improve its environmental performance.

## KB VALUE

The Kauri Butanol (KB) value is a measure of the relative solvent power of a hydrocarbon liquid. The higher the KB value, the more powerful the solvent.

## MODULUS

Where two substrates/surfaces are bonded together with either an adhesive or sealant, they are often subject to forces which could, with enough pressure, result in the bond failing. Modulus is measured in Pascal's. Low modulus means the bond is more flexible and has more 'give' in it, i.e. good for expansion joints. High modulus means that the bond is stiffer and less flexible.

## MRO

Abbreviation for the term "Maintenance, Repair, and Overhaul". Typically associated with the service and repair sectors, including plant and site maintenance / engineering.

## NLGI GRADE

A widely used classification for lubricating greases established by the National Lubricating Grease Institute and a reference to the measure of the consistency of a particular grease. The most common consistency number is #2. Softer grades, especially #0 and #1, are often used for improved low-temperature service. High consistency numbers, #3 through #6 are used for certain high-speed bearings where leakage and sealing are particular concerns. The higher the number, the more viscous the grease.

## NSF EXPLAINED

NSF is an abbreviation for the National Sanitation Foundation, which was founded in 1944 as a not-for-profit, non-governmental organisation. NSF International is a global provider of public health and safety risk management solutions to companies, governments and consumers. In 1999, it launched its voluntary Non-food Compounds Registration Program to re-introduce the previous authorisation program administered by the U.S Department of Agriculture (USDA). Product evaluation is based on formulation and label review and products which comply with the relevant regulations and guidelines receive a Letter of Authorisation and are included in the 'NSF White Book'<sup>TM</sup>.

## NSF CATEGORIES

Acceptable for use as a general cleaner on all surfaces in and around food processing areas, where its use is not intended for direct food contact. All food products and packaging materials must be removed or protected prior to product use. After use of this product, surfaces should be rinsed with potable water. The cleaner should not exhibit a noticeable odour nor leave a visible residue.

### A7

Acceptable as a metal cleaner and polisher for non-food contact surfaces (A7) in and around food processing areas. All food products and packaging materials shall be removed or carefully protected prior to usage. This compound must be used in a manner so that all odours associated with the compound are dissipated before food products or packaging materials are re-exposed in the area.

### A8

Acceptable for use as a degreaser or carbon remover for food cooking or smoking equipment, utensils, or other associated surfaces in and around food processing areas, where its use is not intended for direct food contact. All food products and packaging materials be removed or protected prior to product use. A potable water rinse of cleaned surfaces is required after use of this product.

### C1

Acceptable for use in inedible product processing areas, non-processing areas, and/or exterior areas of food processing establishments provided that it is not used to mask odours resulting from unsanitary conditions, and that any characteristic odour or fragrance does not penetrate into an edible product area. When used on equipment that will be returned to a food processing area, the product must be completely washed off and rinsed with potable water before returning to the processing area.

### D2

Acceptable for use as a sanitiser on all surfaces not always requiring a rinse in and around food processing areas. Before using this compound, food products and packing material must be removed from the room or carefully protected. A potable water rinse is not required following the use of this compound on previously residue remains which can adulterate or have a deleterious effect on edible products.

## 3H

This product is acceptable for use as a Release Agent on grills, ovens, loaf pans, boning benches, chopping boards, or other hard surfaces in contact with meat and poultry food products to prevent food from adhering during processing.

## M1

This product is acceptable for use as a mould release agent on moulds that are used to produce packaging material that will contact food to prevent the finished product from adhering to the mould. The amount used on the equipment should be the minimum required to accomplish the effect.

## H1

This product is acceptable as a lubricant with incidental food contact for use in and around food processing areas. Such compounds may be used on food processing equipment as a protective anti-rust film, as a release agent on gaskets or seals of tank closures, and as a lubricant for machine parts and equipment in locations in which there is a potential exposure of the lubricated part to food. If used as an antirust film, the compound must be removed from the equipment surface, leaving the surface effectively free of any substance which could be transferred to food.

## H2

Acceptable as a lubricant where there is no possibility of food contact (H2) in and around food processing areas. Such compounds may be used as lubricants, release agents, or antirust films on equipment and machine parts in locations in which there is no possibility of the lubricant or lubricated part contacting edible products.

## K1

This product is acceptable for use as a cleaner and degreaser for use in non food processing areas, which are used to remove oil, wax, resinous materials, or other substances not removable by using acidic or alkaline cleaning agents. Their use is limited to non-processing areas where there is no possibility of solvent vapours entering a processing area. Food processing equipment or utensils treated with such preparations must be washed with an acceptable detergent solution and thoroughly rinsed with potable water before returning to a processing area.

## K2

This product is acceptable for use as a solvent for cleaning electronic instruments and devices, which will not tolerate aqueous cleaning solutions in and around food processing areas, where its use is not intended for direct food contact. Before using this compound, food products and packaging materials must be removed from the area or carefully protected. This compound must be used in a manner so that all odours associated with the compound are dissipated before food products or packaging materials are re-exposed in the area.

**K3**

This product is acceptable for use as an adhesive or glue remover, for removing adhesive or glue from food packaging materials in and around food processing areas, where its use is not intended for direct food contact. Before using this compound, food products and packaging materials must be removed from the area or carefully protected. After using these compounds, all surfaces must be thoroughly washed with an acceptable detergent solution, and rinsed with potable water. This compound must be used in a manner so that all odours associated with the compound are dissipated before food products or packaging materials are re-exposed in the area.

**P1**

For Universal Screen Cleaner: This product is acceptable for use as a TFT, LCD and plasma screen cleaner, in and around food processing areas. The products must only be used in such a manner as to ensure it will have neither direct nor indirect contact with food or potable water.

**OZONE DEPLETERS**

Halogen-containing substances known to reduce the protective effects of the stratospheric ozone layer. Aerosols manufactured within Europe have been free of ozone depleting substances for many years.

**pH**

A scale ranging from 0 to 14 used to measure acidity and alkalinity. The lower the number the more acidic; the higher the number, the more alkaline; 7 is neutral.

**POTABLE WATER**

Water of sufficient quality to serve as drinking water is called potable water whether it is used as such or not. Although most fresh water sources are drinkable by humans, they can be a disease vector or cause long-term health problems if they do not meet certain water quality guidelines.

**PTFE**

The abbreviation for polytetrafluoroethylene, PTFE, appears in the Guinness Book of Records as having the lowest coefficient of static and dynamic friction of any solid. This value, at 0.02, is equivalent to wet ice on wet ice, indicating its extreme anti-friction properties.

**REACH**

Registration, Evaluation and Authorisation of Chemicals. REACH is an EU-wide reform of the regulatory environment in which chemicals are used and will eventually replace and update many other pieces of chemical control legislation. The aim is to reduce the risks to human health and the environment through the methodical and accurate identification of the properties of chemical substances. Whilst there is no definitive list of 'approved' chemicals as yet, a series of deadlines will ensure that the highest volume and most harmful are evaluated first. REACH relies on end-user application information to be filtered up through the supply chain to establish accurate registration and evaluation. More information can be found at: [www.hse.gov.uk/reach](http://www.hse.gov.uk/reach).

**RAL**

In 1925, the private sector and the German government founded the "Reichsausschuss für Lieferbedingungen" - RAL - (Committee of the German Reich for Terms and Conditions of Sale). RAL's original task was to standardise precise technical terms of delivery and sale. The RAL colour collection comprises over 200 colours with a four-digit numbering. The registers also include safety and signal colours and they comply with the requirements of the DIN standards (German Industrial Standards). The basic collection for matt colour shades is the register RAL 840 HR while it is the RAL 841 GL register for gloss colours. RAL 840 HR is the European-wide 'registered' standard colours for the coatings industry.

**RTV (ROOM TEMPERATURE VULCANISATION)**

Vulcanisation refers to a specific curing process of rubber involving high heat and the addition of sulphur. It is a chemical process in which polymer molecules are linked to other polymer molecules resulting in springy rubber molecules which become cross-linked. This makes the material harder, much more durable and also more resistant to chemical attack. Vulcanisation which occurs without the need for heat and sulphur, usually by the addition of activating chemicals, is known as Room Temperature Vulcanisation as the rubber 'cures' at around 25°C.

**SHELL 4-BALL WELD**

An industry standard test which provides an indication of the load bearing capability of a lubricant. A steel ball is loaded and rotated against 3 fixed steel balls for 10 seconds. At the end of each 10 second run, a further weight is loaded onto the balls, and the test re-run using fresh lubricant. The test is complete when the balls weld together. The weld point is the load at which this occurs. The higher the weld point, the greater the lubricity (lubricating ability) of the grease.

**SURFACTANT**

A descriptive term derived from 'Surface Active Agent', a specialised compound that is typically used to connect water soluble and water insoluble chemical groups. Can be used to improve the emulsifying, foaming, dispersing and wetting properties of a product

**THIXOTROPIC**

A term used to describe fluids which are shear thinning. In essence, most thixotropic substances are gel-like, meaning that they retain their shape upon application, but when heated or subjected to shear stress, their shape will change and they will become thinner. The word comes from the Greek 'thixis' for touch and 'tropy', from 'tropos' meaning changeable.

**USDA**

The USDA (United States Department of Agriculture) used to authorise the use of non-food compounds, including cleaning agents and lubricants, within the Food Industry sector. In 1999, this former authorisation program was reintroduced as a voluntary registration program by NSF International. USDA categories for lubricants: USDA H1 for incidental food contact (above the food line) USDA H2 for where there is no possibility of food contact (below the food line).

**VISCOSITY**

A term used to describe the resistance to flow or degree of 'thickness' of a liquid, usually expressed in units of poise or stokes. The more viscous a product, the thicker its consistency.

**WELLS DISEASE**

Weil's disease is a particularly dangerous disease which is predominantly caught from standing water infected with the pathogen (bacteria) known as Leptospira, from rat and rodent urine. Symptoms are similar to those of influenza, meningitis, hepatitis, dengue or viral haemorrhagic fevers and can be fatal if left untreated.

**WRAS**

The Water Regulations Advisory Scheme is the UK Water Industry's approval scheme. Products approved by the scheme have been shown to comply with the requirements of the Water Supply (Water Fittings) Regulations 1999 and amendments. The scheme is designed to promote knowledge of the regulations with a view to preventing the waste, undue consumption, misuse or contamination of drinking water. Approved products can be found at [www.wras.co.uk/directory](http://www.wras.co.uk/directory).

**Misrepresentation Act 1967 & Trade Descriptions Act 1968**

The information given in this publication is based on our experience and reports from customers. There are many factors outside our control and knowledge which affect the use and performance of our products and for which reason no warranty is given, express or implied. Users should make their own tests to determine the applicability of such information or the suitability of any products for their own particular purposes. Statements concerning the use of the products described herein are not to be construed as recommending the infringement of any patent and no liability for infringement arising out of any such use is to be assumed.



## CONTENTS BY NAME

3H OIL FG	38	Formula 14	59	Universal Screen Cleaner	24
5-Minute Epoxy	53	Formula 20	57	White Spirit	17
40+	30	Freezer	27	White Spray Grease	37
5005A Silicone Adhesive Sealant	53	Galva Colour	51	Wire Rope Lubricant	35
5024A Silicone Adhesive Sealant	53	Galvanising Zinc Rich	48	Yellow Hand Cleaner	17
Acrylic Conformal Coating	27	Galva Shine	48	Zinc Primer	50
Acrylic Paint	51	Gasket Stripper GS5	22		
Adhesive HS 300	52	Gear Oil Super 150/220/320 FG	39		
Adhesive MP 100	52	Gear & Wire Rope Lubricant	34		
Adhesive NC 500	52	Glass Cleaner	22		
Adhesive QS 900	52	Graphite Release Spray	36		
AGL 1	31	Green Mould Protective	63		
Air Duster	23	Hand Cleaning Wipes	18		
Air Duster FG	23	Hard Surface Cleaner	15		
Alu Hi-Temp	49	Hard Surface Sanitising Wipes FG	18		
Amberclens	14	HD Sil Release	57		
Amberclens FG	14	High Temperature Gasket Sealant	53		
Amberglide	33	Hi-Load Lube FG	37		
Ambergrease EXL	36	Hydraulic Oil Super 32/46/68 FG	39		
Ambergrease FG1	36	Industrial Degreaser FG	20		
Ambergrease FG2	36	Inox 200	49		
Ambergrease FG3	37	Invertible Air Duster	23		
Ambergrease SIL	38	IPA Solvent	26		
Amberklene FE10	19	Label & Adhesive Remover FG	25		
Amberklene FG	20	Label Remover	24		
Amberklene LO30	19	Leak Detector	45		
Amberklene ME20	19	Lec-Klene	21		
Amberklene ME20	14	Lubricating oil 'LO' 32/68/100	40		
Ambersolv SB1	21	Machine Oil FG	30		
Ambertron	25	Marker Pens	50		
AMS4 Silicone Grease	38	Moisture Remover FG	30		
Anti-Static Spray	24	Mould Cleaner	65		
Aqua Marker Pens	50	Mould Protective	63		
Assembly Paste FG	34	Mould Solv	65		
BA40 solvent	21	MPR 100	60		
Battery Terminal Protector	49	MPR 200	61		
Belt Dressing FG	35	Multi-Lube	31		
Bioweld	45	Multi Oil 32/46 FG	40		
Blue Adhesive Lubricant	35	Multi-Surface Polish	22		
Blue Mould Protective FG	63	NF Precision Cleaner	25		
Brake Cleaner	19	Non-Silicone Release FG	59		
Bright, Cold Galvanise	48	No-Sil Release	60		
CCL 100	26	Paint & Graffiti Remover	22		
Chain Lube FG	35	PCB Cleaner	26		
Chainspray	34	Penetrating Oil	31		
Citrus Cleaner & Degreaser	15	Penetrating Oil FG	31		
Clear Mould Protective	64	Polyester Mould Cleaner	65		
Cold Galvanise	48	Polyklene R	64		
COM 300	61	Polymer Remover	64		
COM 400	61	PUR 101	61		
Contact Cleaner FG	25	PUR 300	62		
Copper Anti-Seize Paste	34	PUR 400	57		
Corrosion Inhibitor	49	PX24	30		
Degreaser FG	15	RBR 100	62		
Degreaser RTU & Degreaser Low Foam	14	RBR 310	62		
DP17	17	Release 100	60		
DP 200	60	ROM 300	62		
Dry Film Anti-Stick	33	Rust Converter	50		
Dry Moly	33	Rust Flash	32		
Dry PTFE Lube FG	33	SBP 11	16		
Duster Lo-GWP	24	Silicone Anti-Stick	32		
Dust Remover	23	Silicone FG	32		
Easy Weld	45	Silicone Lubricant	32		
Ejector Pin Lubricant	63	Silicone Oil	38		
Engineers Wipes	18	Silicone Release FG	57		
Fast Clean 200/201	21	Solvent Cleaner FG	20		
Flaw Detectors:Cleaner/Penetrant/Developer	45	Solvent Cleaner FG	65		
Flux Remover	26	Solvent Degreaser	20		
Food Grease FG	37	Solvent Free Hand Cleaner	17		
Formula 1 & Formula 1 HT	56	Spatter Release	44		
Formula 2	56	Stainless Steel Cleaner FG	15		
Formula 4	58	Sugar Remover & Inhibitor FG	16		
Formula 5	58	SV100	27		
Formula 6	58	Terrazzo Cleaner	16		
Formula 7	58	Tool Guard	64		
Formula 8	56	Tough Wipes	18		
Formula 10	58	Traffic Film Remover	16		
Formula 11	59	Tufcut:Liquid/Spray/Foam/Compound/Aqua	44		
Formula 12	59	Ultrasonic Cleaning Fluid	27		







# Ambersil

Ambersil House  
Wylds Road  
Bridgwater  
Somerset  
TA6 4DD  
United Kingdom

[www.ambersil.com](http://www.ambersil.com)

**t** +44 (0)1278 727200

**e** [sales.uk@ambersil.com](mailto:sales.uk@ambersil.com)

© CRC Industries UK Ltd. 2014



BS EN ISO 9001:2008  
BS EN ISO 14001:2004  
MoD Approved Contractor

